



smart Sol plus

Equipment >Excellence<

Assembly and Operating Instructions
Differential temperature controller for solar thermal
plants for drinking water heating and heating support

These Assembly and Operating Instructions are an integral part of the product.

- > Read Assembly and Operating Instructions carefully before using the product.
- > Keep them in a safe place during the product's service life.

Translation from the German original edition ©emz 2012 - Subject to modifications.

The contents and representations of these Assembly and Operating Instructions are the intellectual property of emz-Hanauer GmbH & Co.KGaA.

Non-authorized disclosure, reproduction, divulgation or editing of this documentation, as well as exploitation, utilization or publication, are prohibited.

The rights to the word and design marks ›emz - smart solutions‹ and ›**smart Sol plus**‹ are the exclusive property of emz-Hanauer GmbH & Co.KGaA.

The rights to any cited brands, names or logos are the property of their appropriate developers / of the licensees in question.

Table of contents	Page
Important fundamental information	4
Symbols used	5
Description	6
Dimensions	7
Technical Data	8
Designation of the components	10
Operation of the controller	11
Display	12
Opening the terminal cover	13
Wall-mounting	14
Connection to power supply	15
Data interfaces	19
Hydraulic systems	20
Functions for boiler control	51
Thermostat functions	54
Soft water station AQA solar	55
Commissioning mode	57
Automatic mode	63
Operation mode	64
Malfunction	78
Replacement of fuse	85
Professional mode	86
Disassembly/Disposal	107
Warranty and liability	108
Error report	109
EC Declaration of conformity	111
Index	112

Important fundamental information

These instructions describe installation, commissioning, operation, repair and disassembly of the differential temperature controller **smart Sol plus** for solar thermal plants.

For operation of the entire plant, the technical documentation of all the components used such as solar collectors, boiler, tank, pumps, mixers and valves etc. must be complied with.



Danger!

Assembly, connection, commissioning, repair and disassembly of the controller may only be performed by a qualified specialist!



The controller is handled by the operator of the entire solar thermal plant, i. e. as a rule by technical non-experts.



Danger!

The controller by no means replaces the safety components required under plant engineering aspects!



Make sure not to use the controller until you have thoroughly read and understood these Assembly and Operating Instructions and the safety provisions. Comply with all safety provisions and involve a specialist in case of doubt.



Important!

The fitter installing the controller must inform the plant operator about operation, functioning and the method of action of the **smart Sol plus!**



Keep these Assembly and Operating Instructions and all reference documents so that they are available if required.

When relocating or when selling the device, hand the documents over to your successor.



Danger!

The device in operation may only be made accessible to adults disposing of appropriate knowledge and experience!



When handling the differential temperature controller **smart Sol plus** and the entire plant, please make sure that the following safety provisions in the Assembly and Operating Instructions are complied with!



Danger!

Immediate danger for assets, life and limb!



Important!

Important information compliance with which is essential!



Note!

Useful information regarding handling of the device and the plant!



Description

The differential temperature controller **smart Sol** plus an independent electronic controller for surface-mounting which is used for the control of solar thermal plants.

The controller is equipped with a robust three-part plastic housing which can only be opened by means of tools (screw driver PH2).

Operation is effected by means of only two control elements; indications appear against a backlit colour display.

Before connection of the electrical system, the controller must be mounted firmly to a perpendicular, robust surface (wall).

For its own supply and the supply of the outputs, the controller must be connected to an electrical energy supply system in accordance with the technical data.

Note!

The electrical equipment of the device must be installed firmly and connected to the power supply via a disconnector ensuring complete isolation from the power supply according to the erection regulations!

Assembly, connection, commissioning, repair and disassembly of the controller are only admissible in a specialist workshop.

To ensure correct operation, temperature sensors type Pt 1000 must be used - the sensor design does not affect function.

Each temperature sensor has two connectors which are equivalent, i. e. interchangeable. Thus, polarity reversal is not an issue.

The sensor lines can be extended up to a length of 100 m, to this effect, a cable cross section of $2 \times 1.5 \text{ mm}^2$ is recommended.

Important!

Make sure that only a dry or slightly moistened cloth is used for cleaning and servicing of the housing, the control elements and the display.

The surfaces must never get into contact with cleaning products or solvents - mat, brittle or slightly dissolved plastic parts must be replaced immediately!

A device with damaged housing must not be operated!

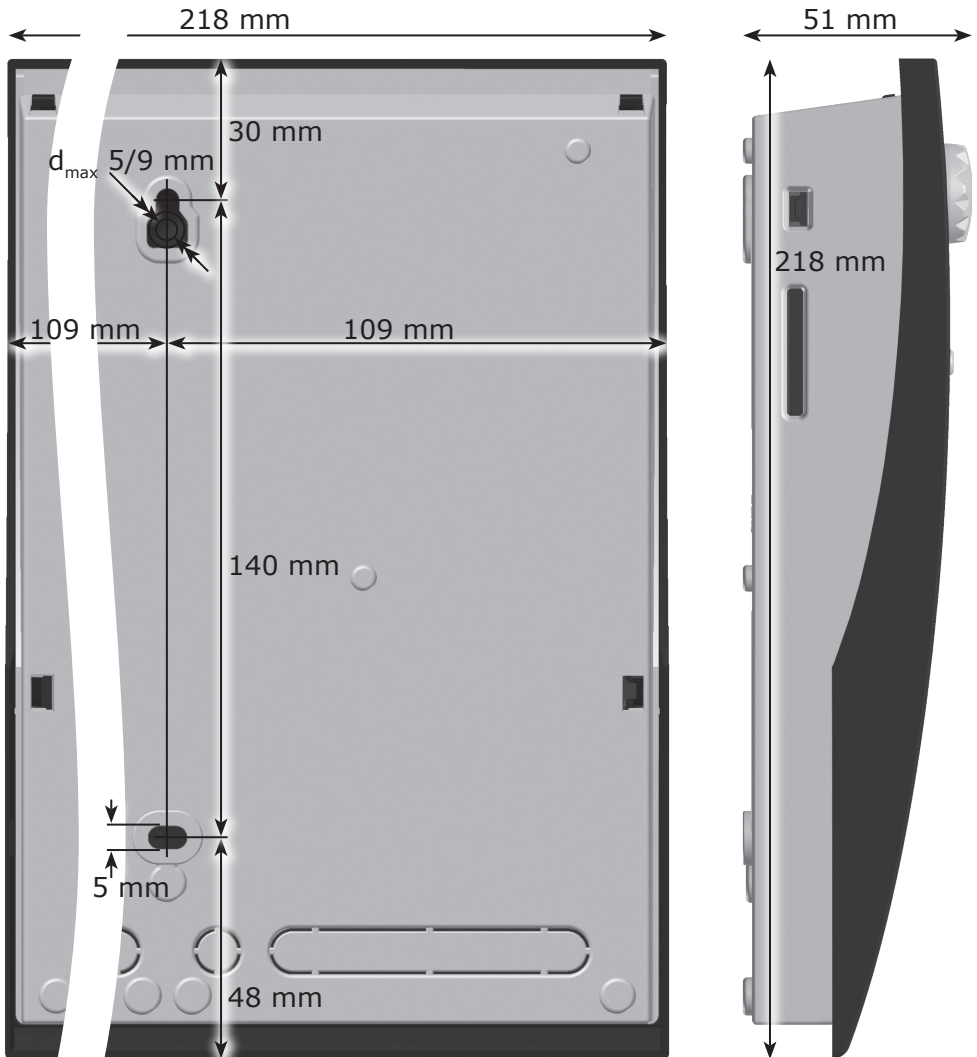

Technical Data

Intended Use

The differential temperature controller may be used exclusively as controller for the control of solar thermal plants. It must be operated within the scope of all the specifications described. Installation and set-up of the controller may only be performed by specialists. The fitter must have read and understood the operating manual. The fitter explains all the relevant functions to the operator. For operation, it is essential that the housing is closed and free of damage.

Scope of supplies

1 Differential temperature controller **smart Sol plus**

1 Instruction manual

Differential temperature controller **smart Sol plus**

Type of mounting	Wall-mounting
Housing	Plastics, in several parts
Mode of operation	Type 1
Type of protection	IP 20
Dimensions Width x Height x Depth [mm]	218 x 218 x 51
Weight [g] Basic version	725
Storage/operating temperature [°C]	0-40, non-condensation
Handling	via rotary encoder and pushbuttons
Display	TFT colour display 70 x 53 mm, backlit

Connection to power supply

Design	3 spring-type terminals PE, N and L
Service voltage [VAC]	85-265
Line frequency [Hz]	50 ±1%
Auxiliary consumption typ. [W]	1.25
Power consumption max. [W]	3.1
Fuse	Micro fuse, type 5 x 20 mm, T4A/250 V
Rated pulse voltage [V]	2500

Max. cross sections to be connected

Cable end sleeve:	0.25 to 0.75 mm ²
Single-wire	0.50 to 1.50 mm ²
Fine-wired	0.75 to 1.50 mm ²

Interfaces TS1 - TS8

Design	2 spring-type terminals each
Assignment as inputs	
Admissible temperature probe	Temperature sensor Pt 1000
Optional assignment of TS6-TS8 to the impeller sensor	DFZ 1-100 pulses/litre
Optional assignment as output on TS7/TS8	PWM signal 100Hz...2kHz or analogue output 0...10V, max. 10mA

Interfaces TS9 - TS10

Design	2 spring-type terminals each
Assignment to the impeller sensor	DFZ 1-100 pulses/litre
Assignment as output	PWM signal 100Hz...2kHz or analogue output 0...10V, max. 10mA

Active outputs RO1-RO4 :Triac outputs

Design	3 spring-type terminals each, PE, N and L
Output voltage [VAC]	85-265
Output power max. per output [VA]	200
Output current max. per output [A]	1

Switching output REL: Floating change-over contact

Design	3 spring-type terminals
Switching voltage max. [V]	253
Switching capacity max. [VA]	230
Switching current max. [A]	1

Interface for analogue Vortex flow sensors

Design	1 multi-pin connector
--------	-----------------------

5V/24V supply terminals

Design	1 spring-type terminal each
Output voltage [VDC]	5V/24V
Max. current per output [mA]	15

Supply terminals L

Design	1 spring-type terminal each
Output voltage [VAC]	85-265

The total current of all outputs including RO1-RO4 must not exceed 4A!

Designation of the components

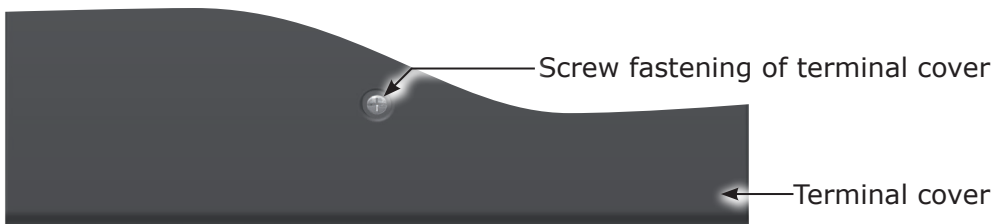
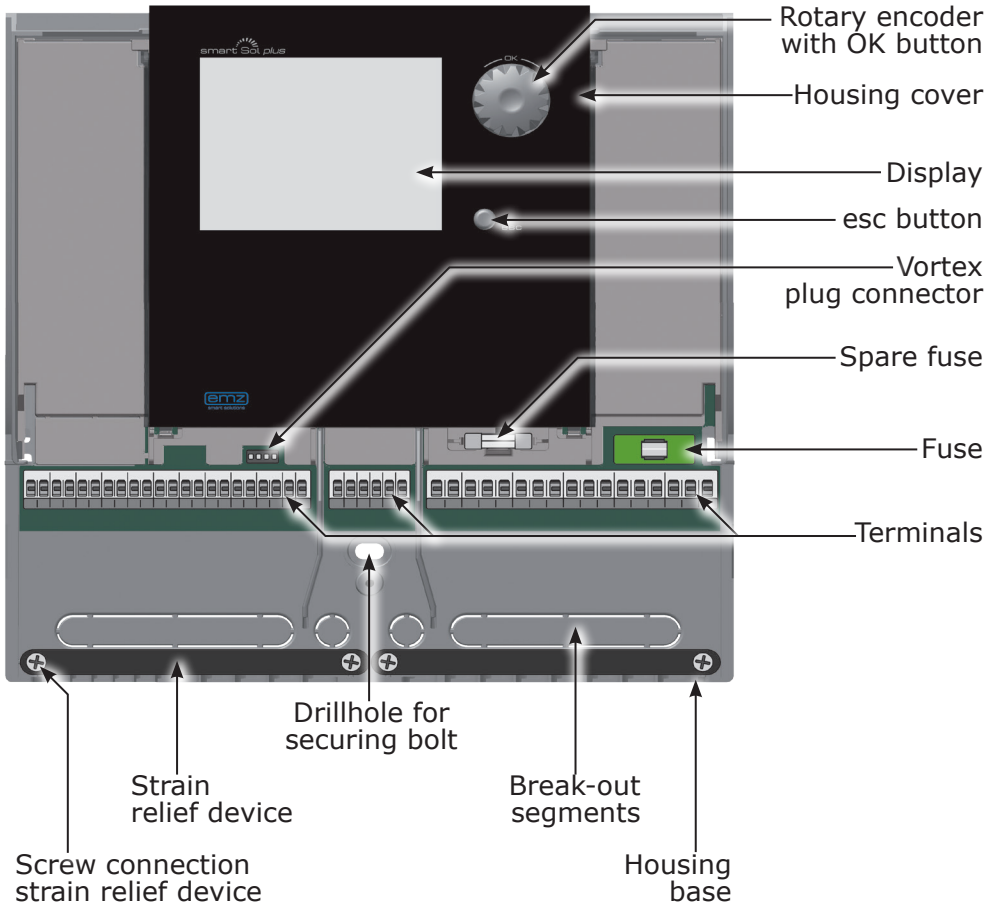

Operation of the controller

The entire set-up and operation of the differential temperature controller **smart Sol plus** is effected via only two control elements on the device front.

All settings and interrogations are effected via the rotary encoder.

To find a required menu item, turn the rotary encoder to >scroll< through the menu - the selectable option appears on a coloured background on the display.

To confirm the selected menu item, press the rotary encoder. An appropriate submenu is called up, or selection is activated.

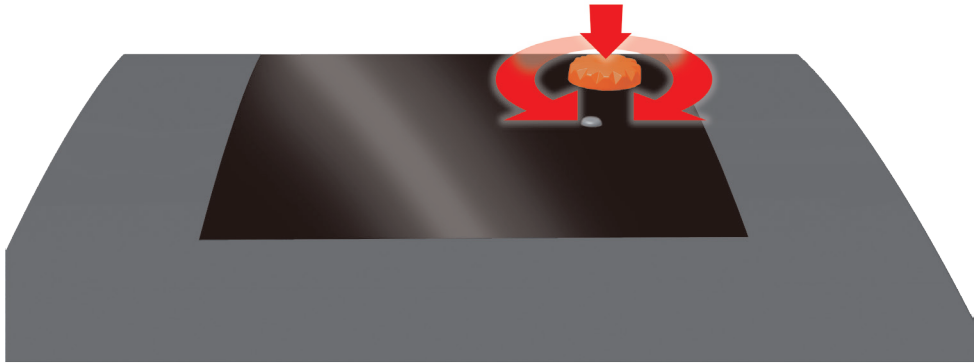

Press the esc button to make the menu return by one level from any subitem.

If no input is made within the preset time (30-255 s), the controller returns automatically to the initial level.

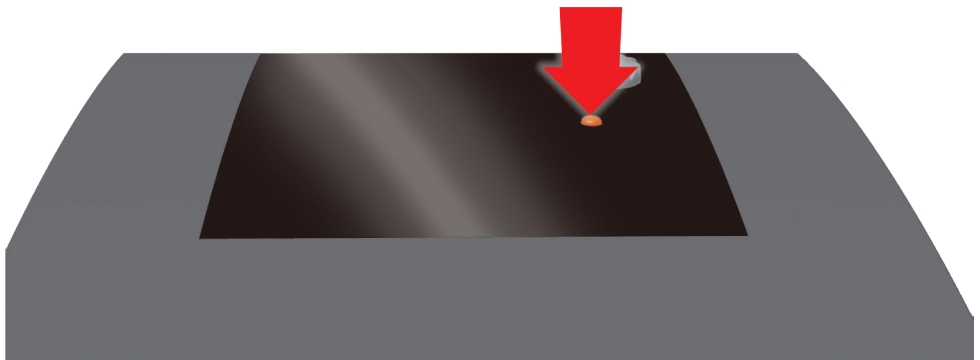

Display

For indication of the operating mode and for communication in case of set-up, malfunction, modification and evaluation, the differential temperature controller **smart Sol plus** is equipped with a coloured full graphics display which is permanently backlit.

The display is active as long as there is supply voltage on the controller.

After a preset time (30 - 255 s), backlighting is dimmed to 10%.

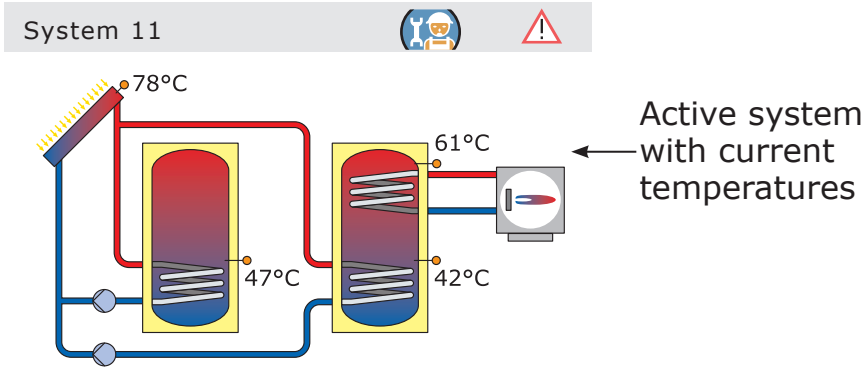

25.08.2012 10:35 ← Date and time

Display elements; example: information screen

Number and name of menu

1.3.2 Tube collector

Professional mode

Manual mode

Message

Activation

Start

t ON 10min

T ON 20.0°C

t solar 1 20s

n solar 1 100%

t solar 2 0s

Check box

Sub menu arrow

Selection menu

Activatable menu item

Scroll arrow

25.08.2012 10:35 ← Date and time

Display elements; example: communication screen



Danger!

Mortal danger due to electrocution! Whenever work is performed on the open terminal cover, all poles of the power supply must be disconnected reliably and protected against being switched on again!

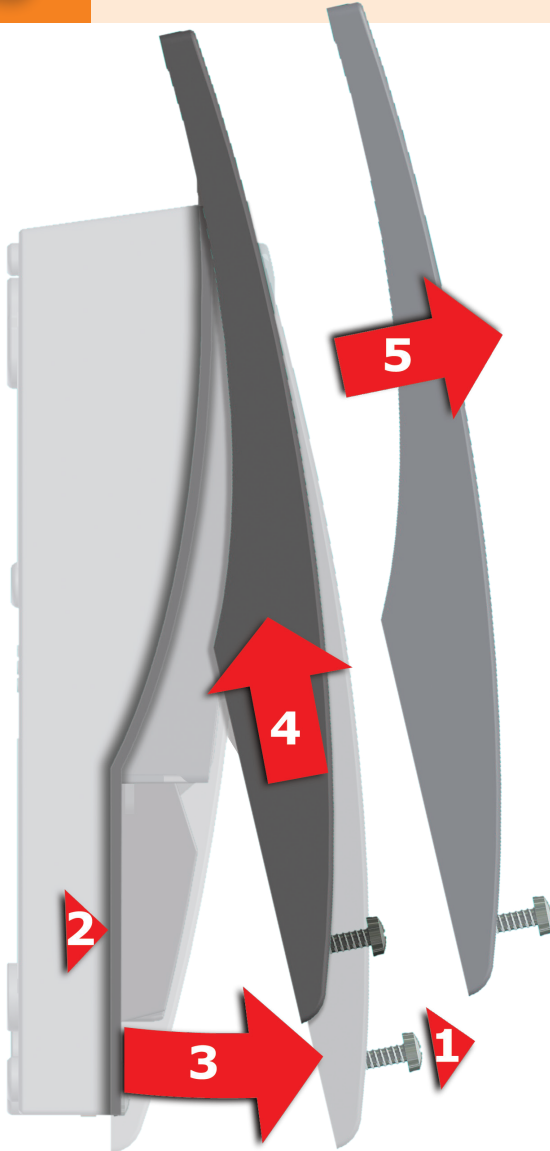

1 Release the lock screw.

2 Pull apart the sidewalls of the terminal cover at the lower third...

3 ...swivel the terminal cover forward ...

4 ... push it upwards ...

5 ... and remove it.

Store the terminal cover carefully and protect it against damage!

To close the terminal cover, reverse the opening procedure.

Important!

The device corresponds to protection type IP 20 - make sure the appropriate prerequisites exist on the envisaged place of installation.

Do not use the housing base as drill template.

A device with damaged housing must not be operated!

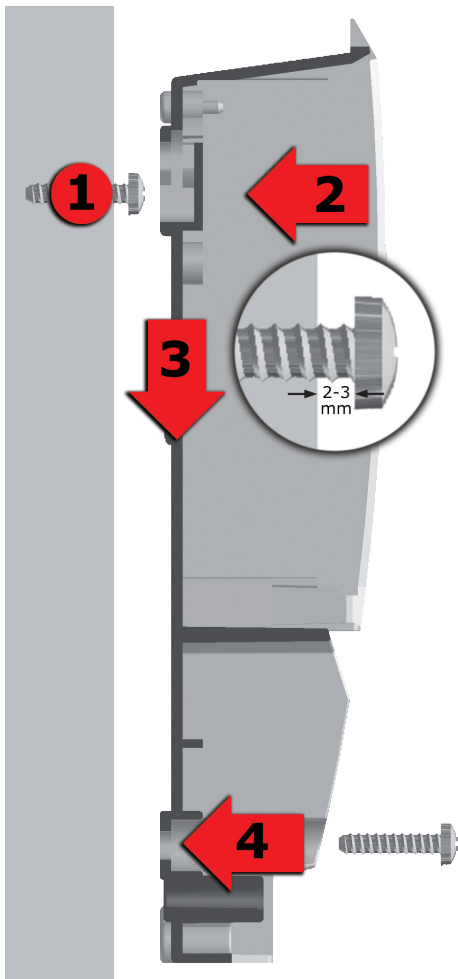

- 1** Fasten the top securing bolt so that a space of 2 to 3 mm is created between the wall and the screw head.
- 2** Move the device so that the upper fastening port is located above the screw head ...
- 3** ... and push it downwards.
- 4** Fasten the lower securing bolt.

If necessary, use dowel pins for wall-mounting!



Danger!

Mortal danger due to electrocution! Whenever work is performed on the open terminal cover, all poles of the power supply must be disconnected reliably and protected against being switched on again!



The differential temperature controller **smart Sol plus** is connected to the power supply via three groups of spring-type terminals which are visible once the terminal cover is opened.

To introduce the cables, release the screws on the strain relief device; if necessary, remove the strain relief device.

In case of flush mounting of the cables, the break-out segments in the housing base can be removed carefully and the cables routed through these ports.

The central terminal block is the interface to a potential-free change-over contact.

The spring-type terminals for the Power, RO1 to RO4 and REL, and for TS1 to TS10 can accommodate solid wires up to a cross section of 1.5 mm².

Appropriate stranded wires must be preassembled with cable end sleeves.

For the strain relief device function, TS1 to TS10 and REL require cable cross sections of at least 5mm, for Power, RO1 to RO4 at least 7mm.

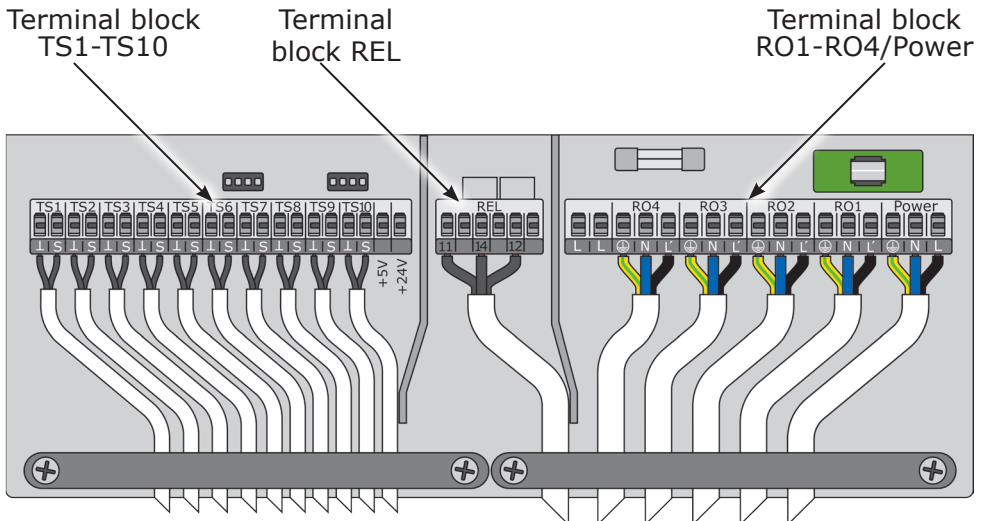

Connection to power supply

Connection of a switching valve to RO1-RO4

Connection diagram for a switching valve without power supply to RO4:

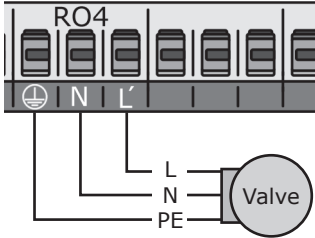

Connection diagram for a switching valve with power supply to RO4:

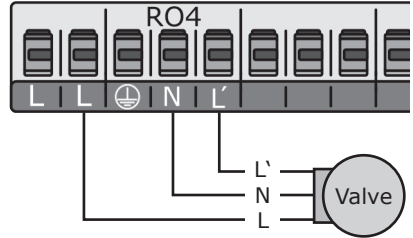

Connection of a switching valve to REL

Connection diagram for a switching valve without power supply to REL:

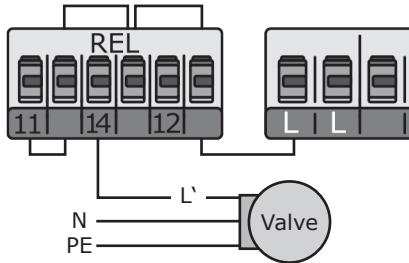

Connection diagram for a switching valve with power supply to REL:

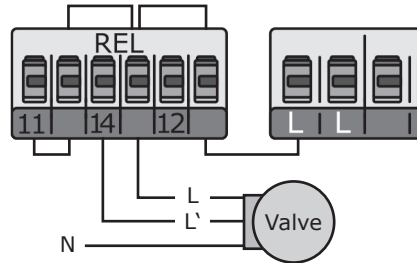

Connection of a pump to REL

Connection diagram for a pump to REL:

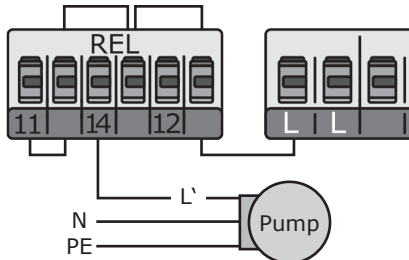

Volumetric flow sensor:

Measurement of solar radiation (heat quantity):

The solar yield is calculated from the flow rate and the differential temperature.

The differential temperature is the difference in the temperature of the collector sensor and the solar circuit return line sensor. There are various technical options:

a) Use of a vortex volumetric flow sensor with 2 analog signals for flow rate and temperature. The vortex sensor can be inserted directly at the plug connector provided behind the TS terminals. All plant layouts (systems) permit solar radiation.

Pin assignment

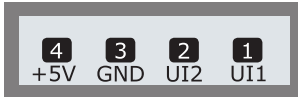

b) Impeller sensor (incrementation input)

An impeller sensor can be connected to TS6 to TS8 and must be adjusted during installation. The temperature sensor for the solar return line must be set in the menu >1.1.4 Heat quantities<.

Solar yield measurement with impeller sensors is possible for all systems.

High-efficiency pump:

A high-efficiency pump can be connected via RO1 to RO4.

The appropriate control signal is issued at TS7 to TS10.

Thus, TS7 to TS10 is no longer available as input.

The control signal may be an analog voltage 0 - 10V or a PWM signal.

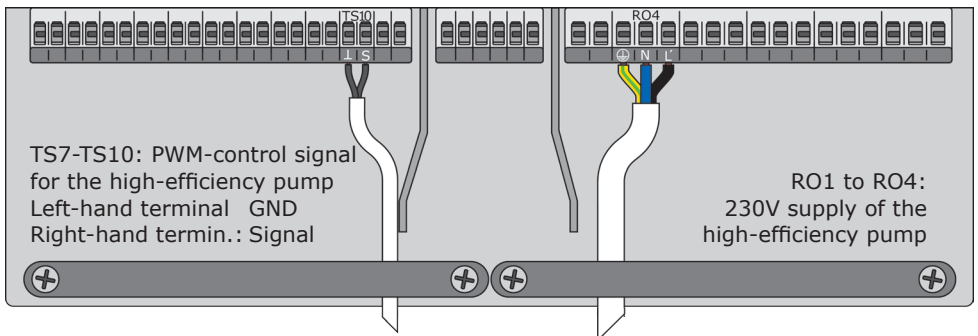

For further details, please refer to the pump specification.

For definition and settings, the professional mode under 1.2.9 has been provided.

The strain relief device can only ensure solid clamping if the cables are not stripped to a length of over 35 mm.

Insulation of the individual wires must be removed over a length of 9 - 10 mm to ensure safe electric contact in the spring-type terminal.

Stranded wires must be provided with cable end sleeves!

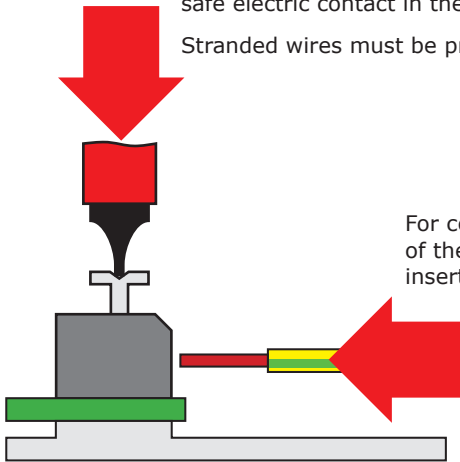
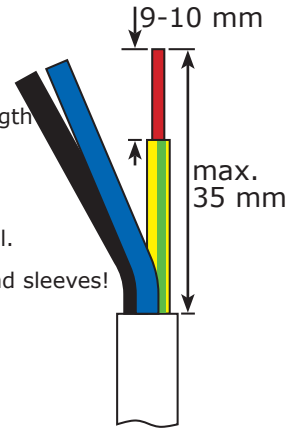

For connection, press the actuation pushbutton of the spring-type terminal using a screwdriver and insert the wire to its stop in the appropriate port.

Release the actuation pushbutton and pull the cable slightly to ensure that it is safely clamped.

Important!

Before closing the terminal cover, make sure the strain relief device is tightened safely.

Check once more that all cables are in good condition and connected correctly.

The solar controller has the following data interfaces:

The cut-outs at the left of the housing base accommodate a USB port as well as a slot for a storage medium (SD card).

These interfaces are used, for example, for reading of error messages or log data or loading of software updates.

The USB port provides access to the SD card.

Only SD cards approved by emz must be used.
The controller automatically detects the SD card.

Prior to removing the SD card
>Rem.SD card safely< must be
selected in >1.2 Settings<,
otherwise data loss may occur.



USB
port

SD card

Hydraulic systems

Note!

Define structure and design of the plant already when planning the entire solar thermal system and align the design with the one of the hydraulic systems of the controller!

If you want to complete an existing system or replace the existing controller, please make sure that **smart Sol plus** is compatible with the existing configuration!

The sensors are connected to TS1 to TS10, the order not being significant; pumps and valves are connected to RO1 to RO4 / REL - The interfaces are assigned to the functions in question on commissioning.



Supply line
Return line



Heating pump

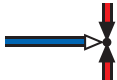

Switching valve

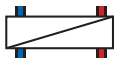

Hydraulic heat exchanger

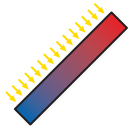

Solar collector panel
Main yield

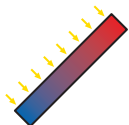

Solar collector panel
Secondary yield



Boiler, e. g. using fossil fuels/ solid fuels/ heat pump etc.



Boiler with disable recharge feature time-/temperature-controlled, in combination



Boiler with disable recharge feature, efficiency optimization

—●— Temperature probe



Swimming pool

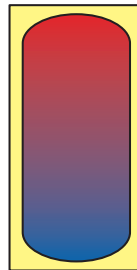

Warm water /
buffer tank without
heat exchanger

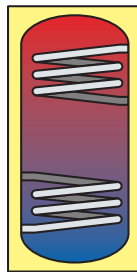

Warmwasserspeicher/
Pufferspeicher mit
Wärmetauschern

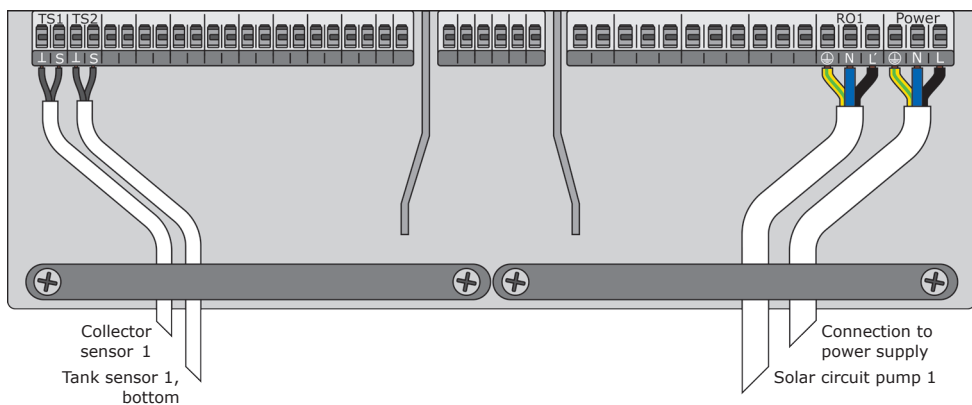
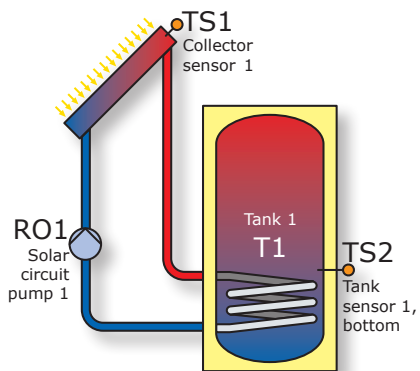

Hydraulic system 2

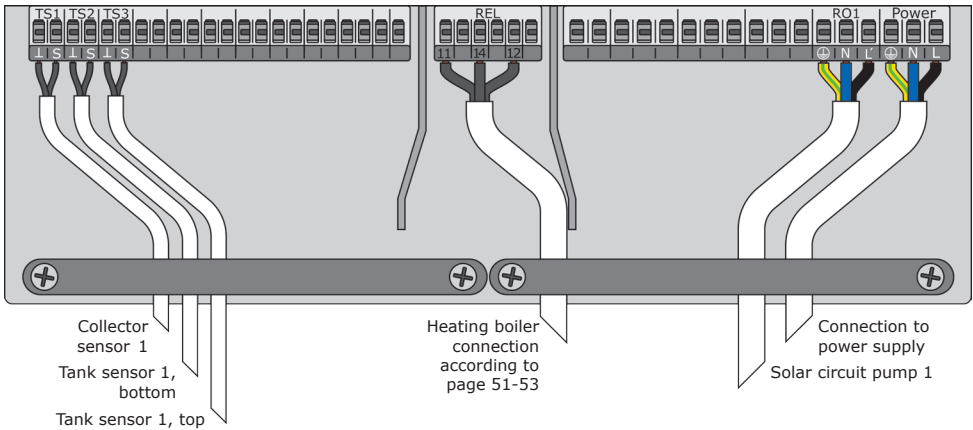
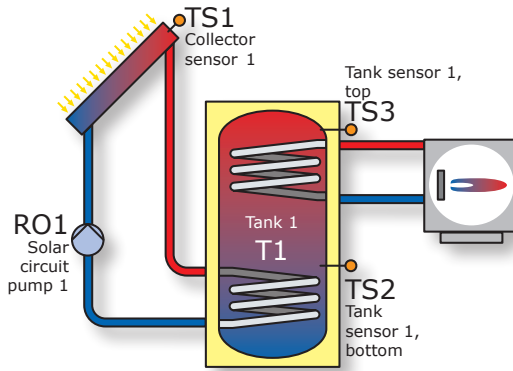

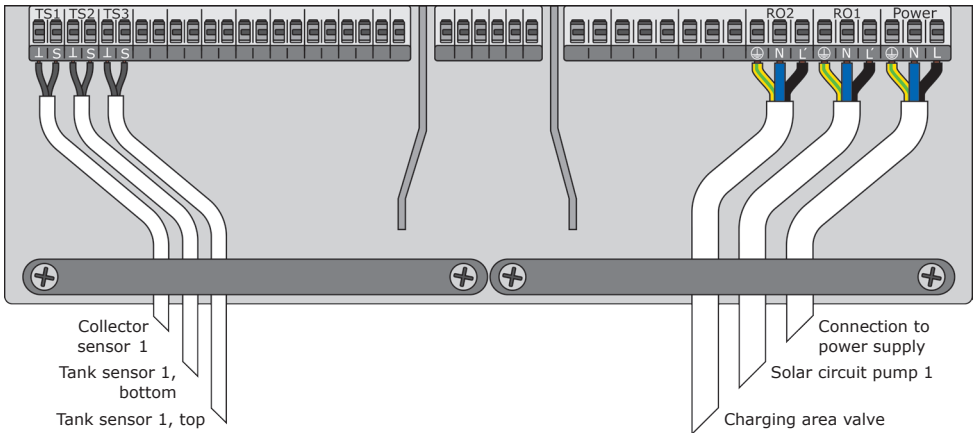
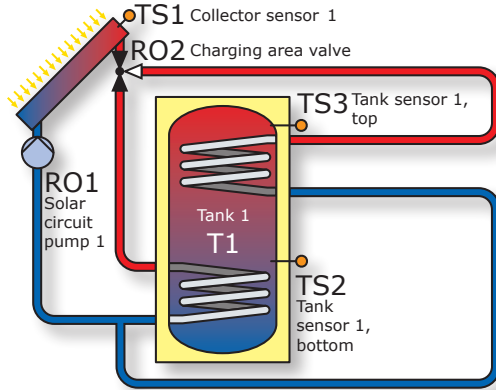

Hydraulic system 4

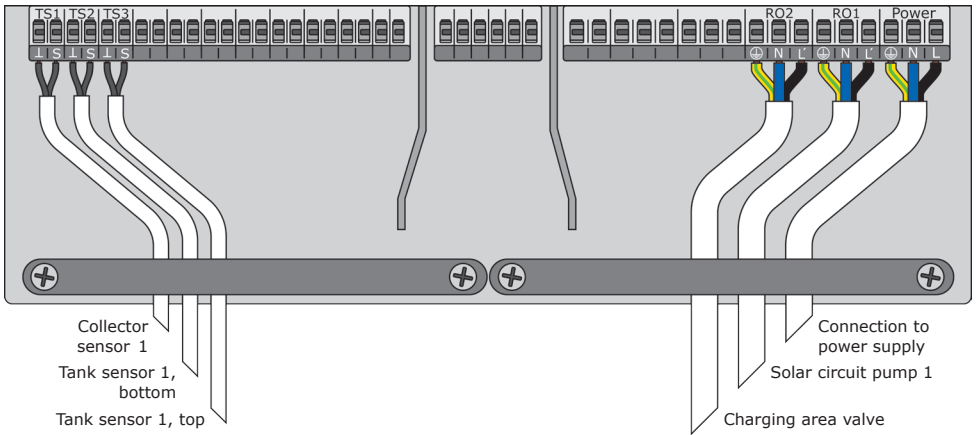
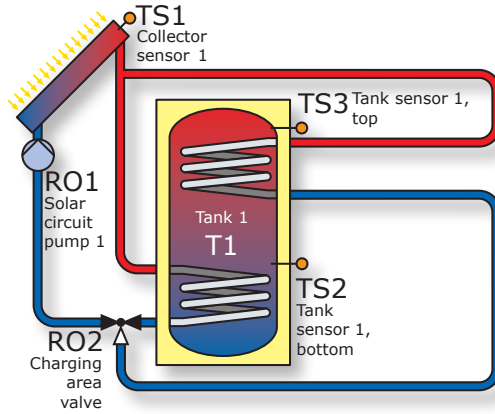

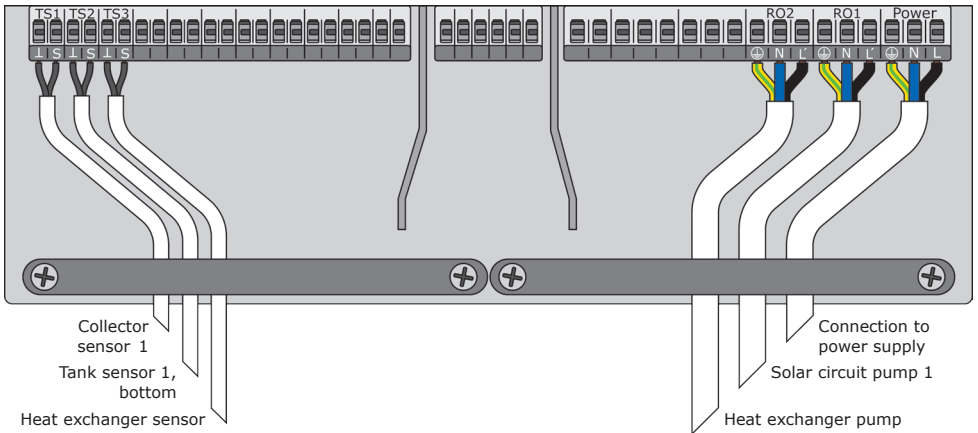
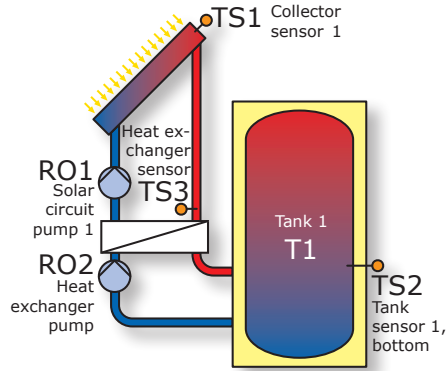

Hydraulic system 6

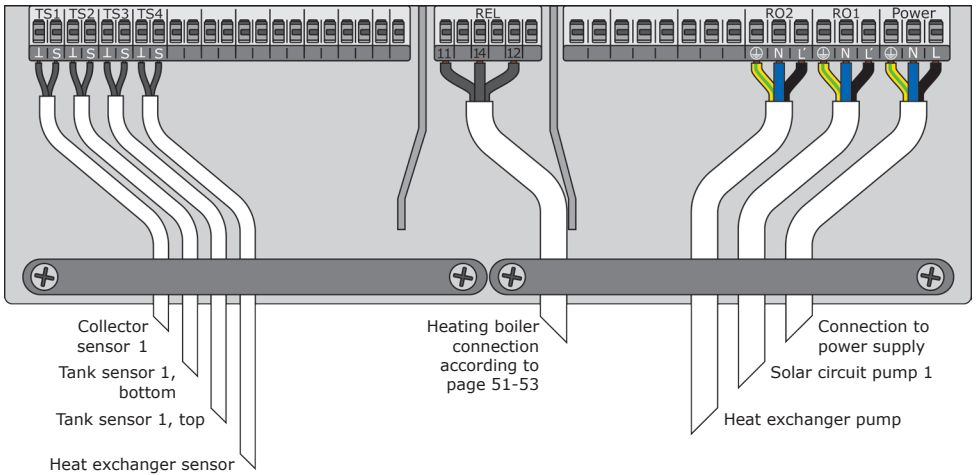
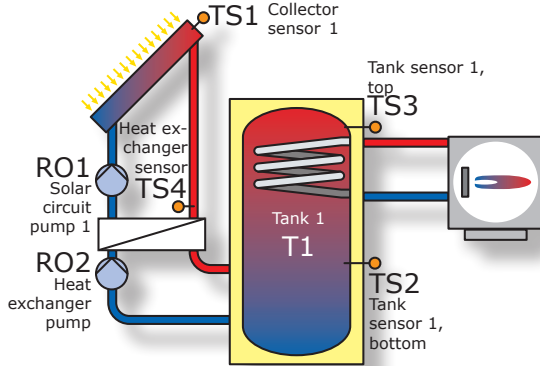

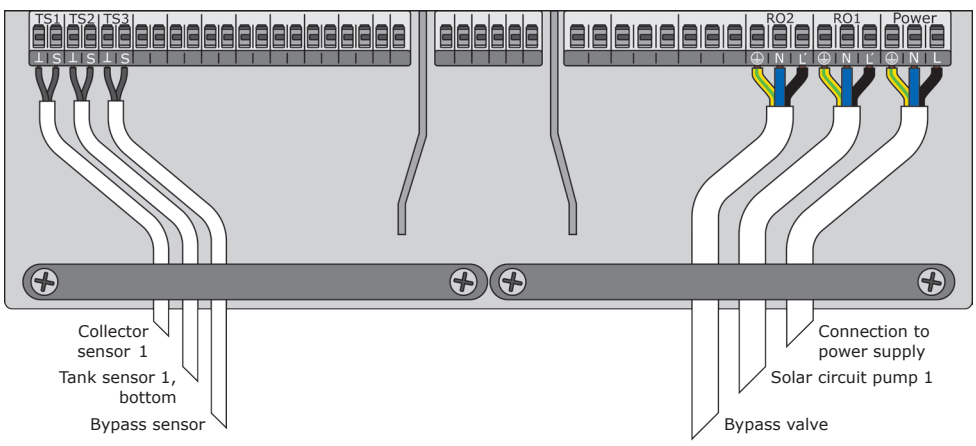
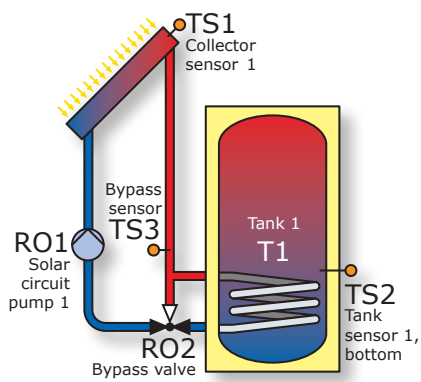

Hydraulic system 8

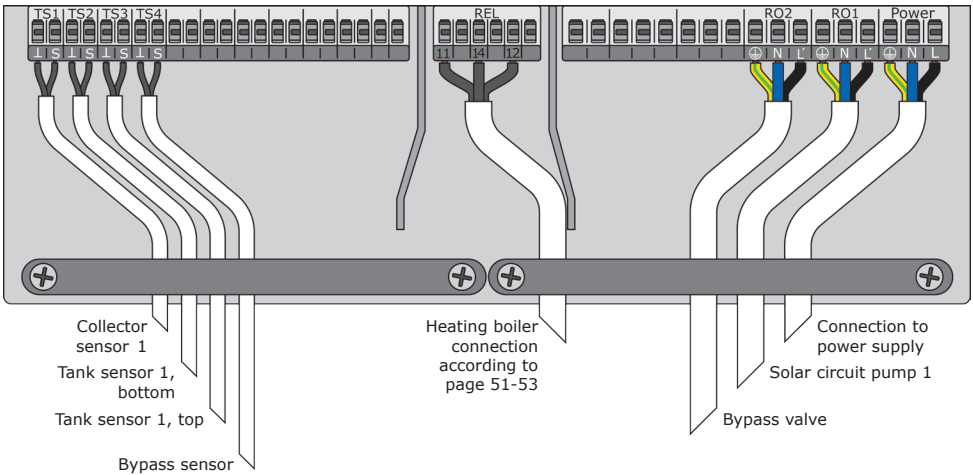
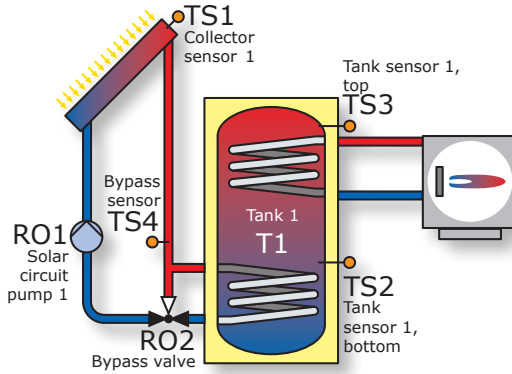

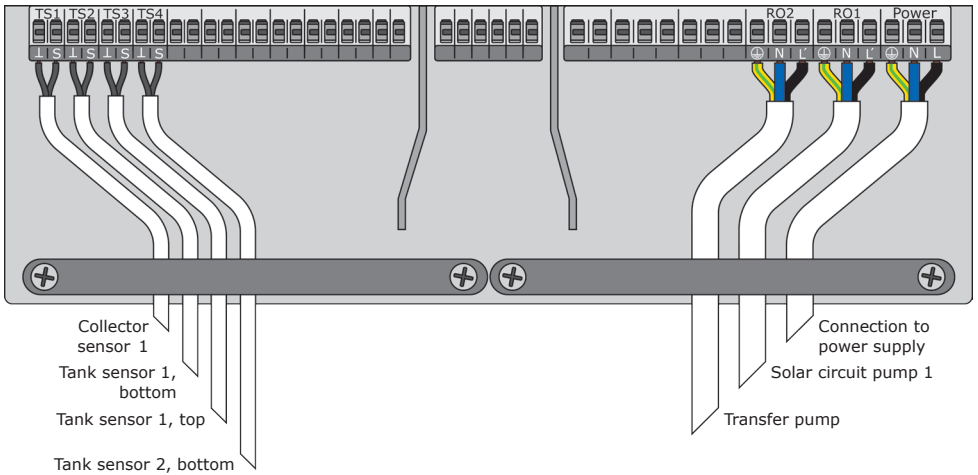
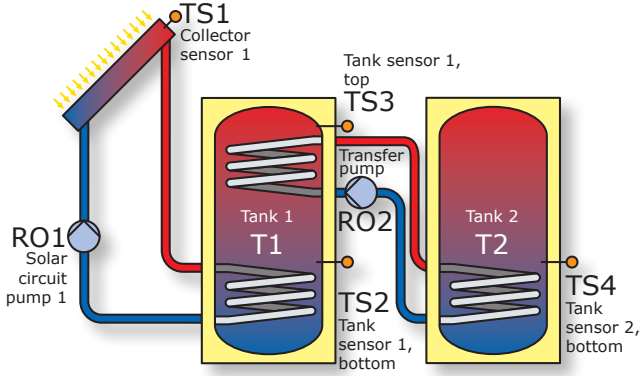

Hydraulic system 10

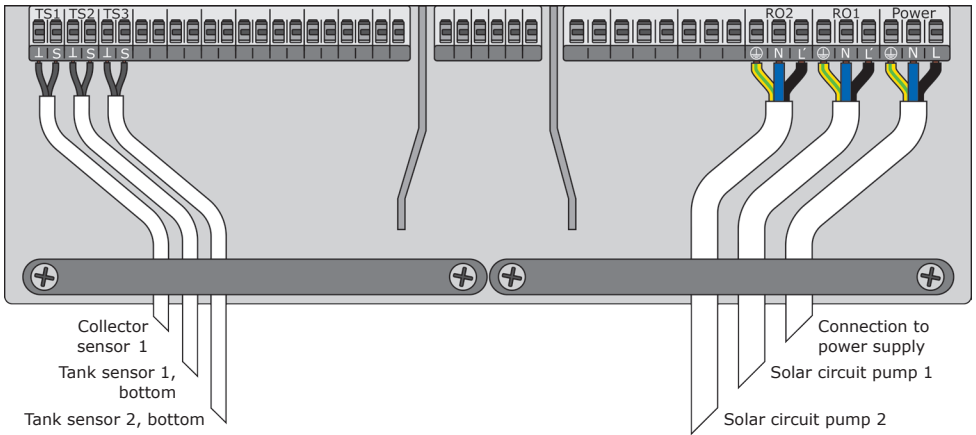
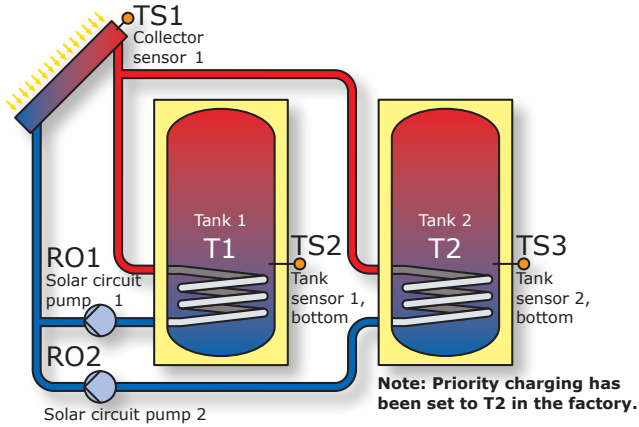

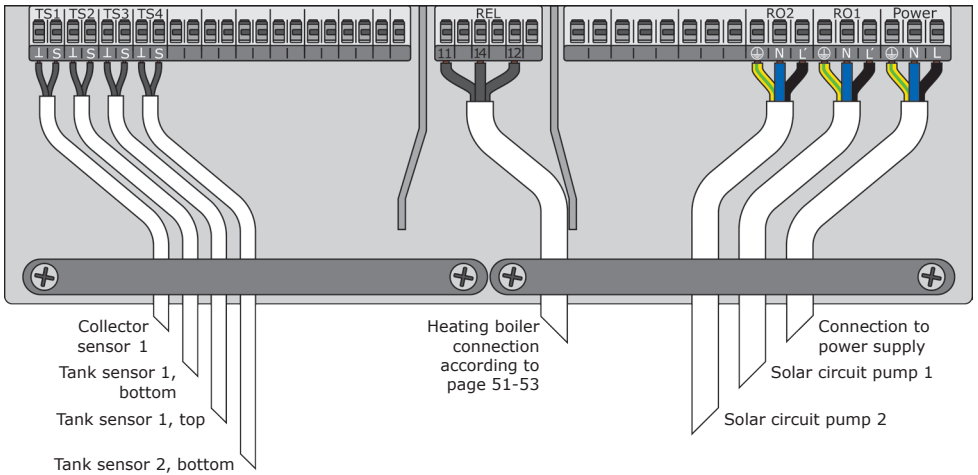
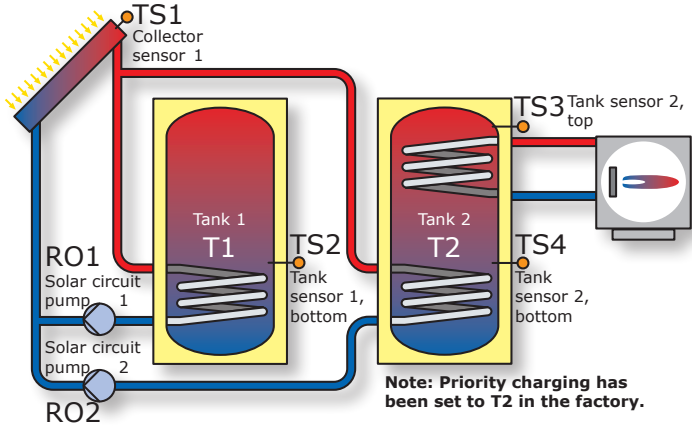

Hydraulic system 12

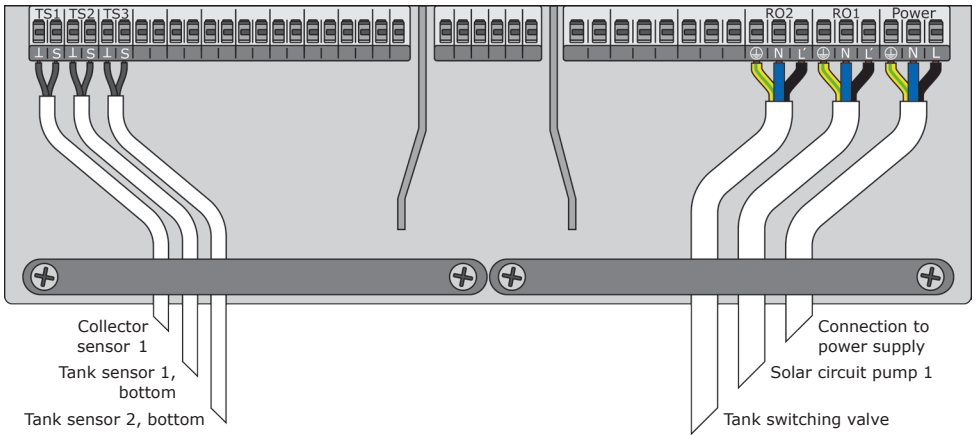
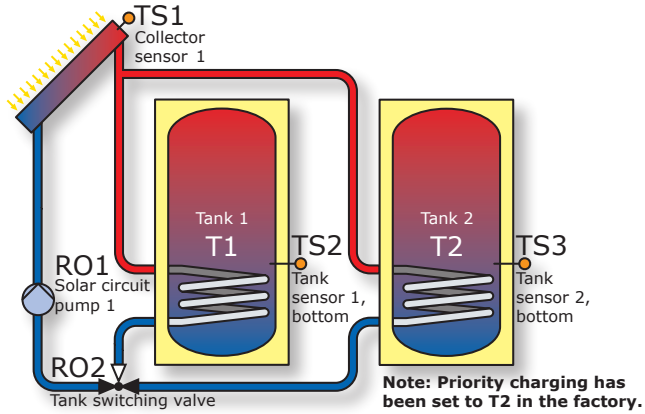

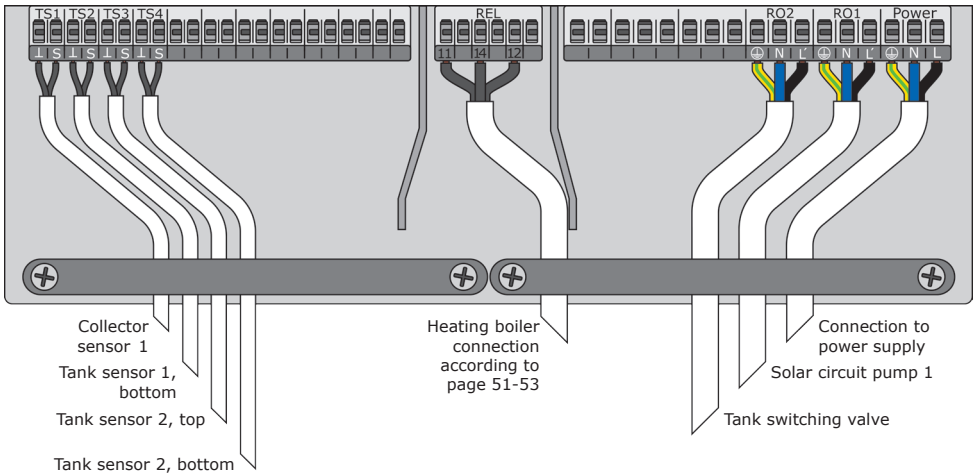
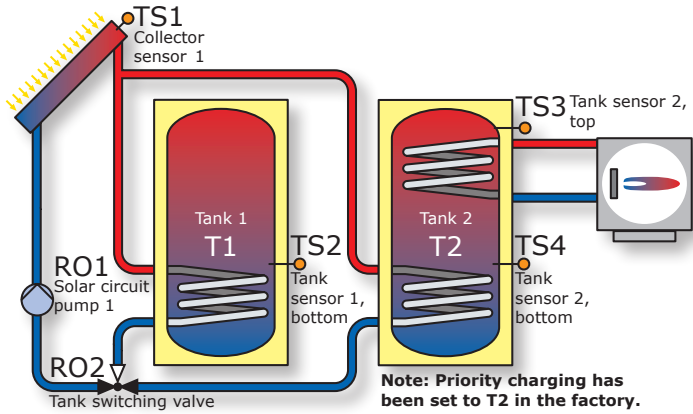

Hydraulic system 14

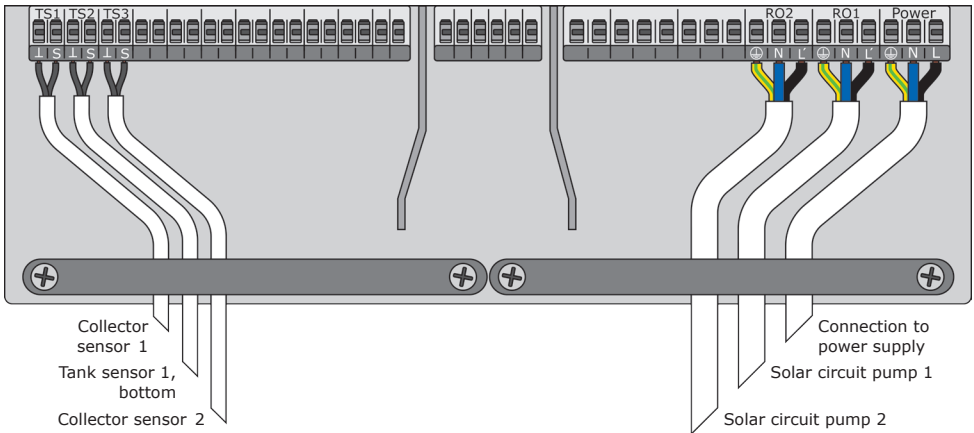
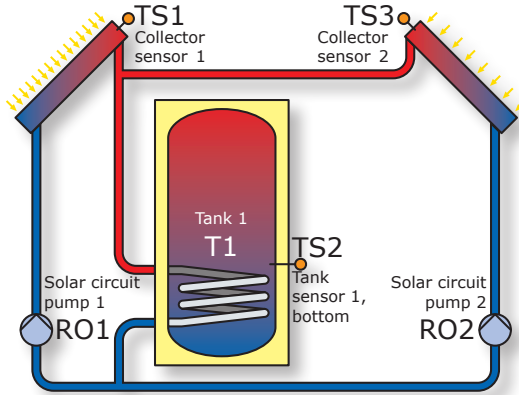

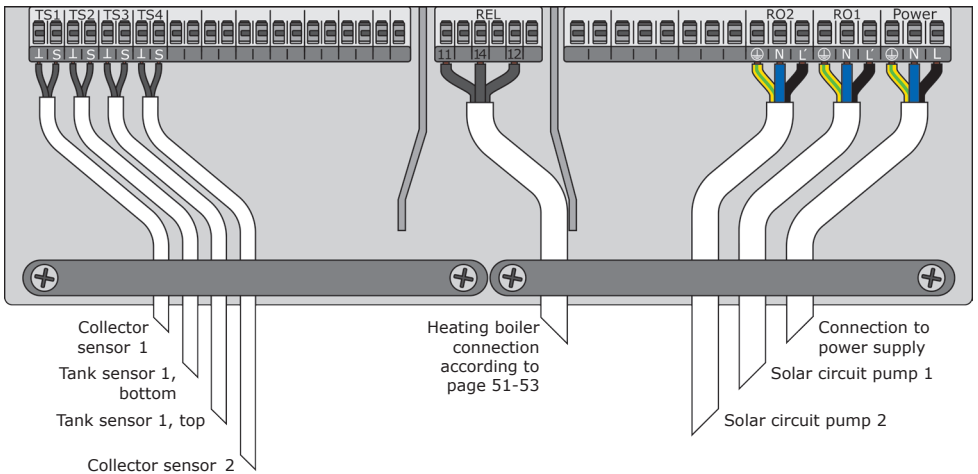
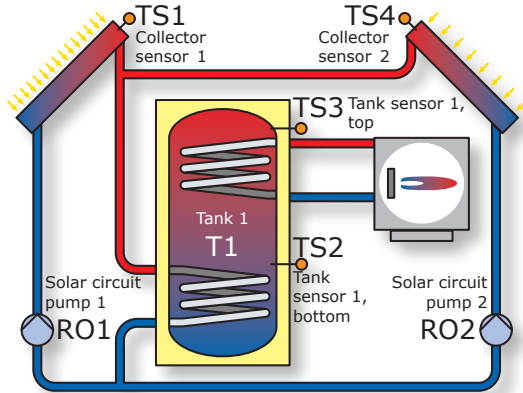

Hydraulic system 16

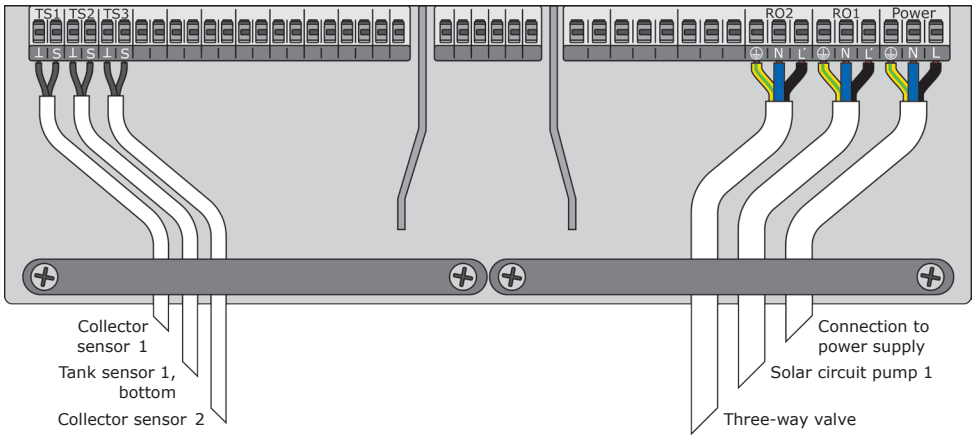
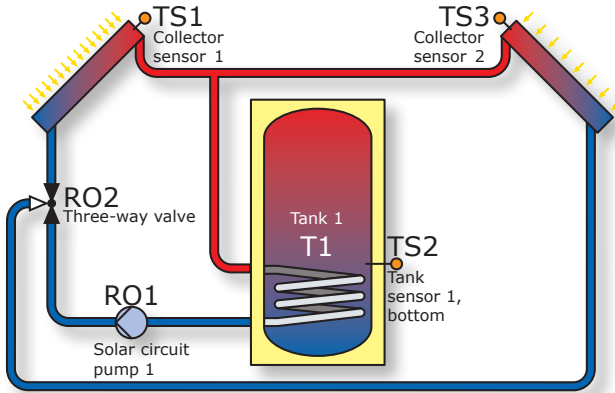

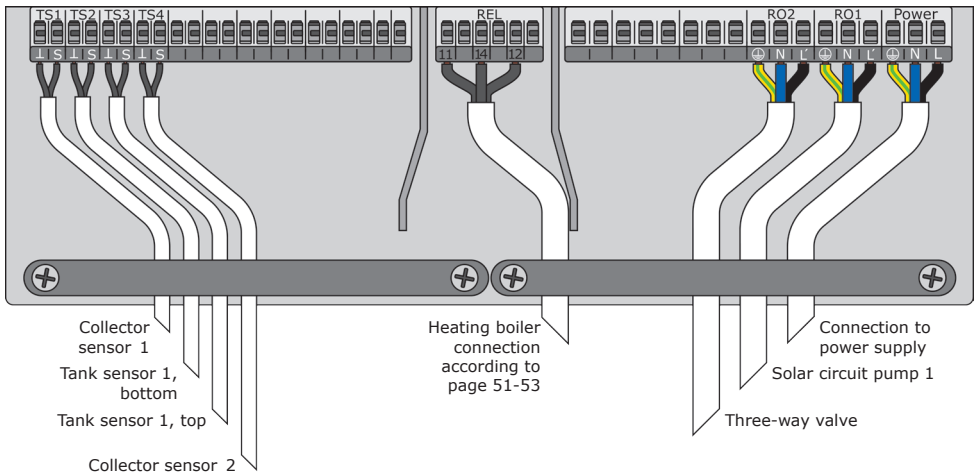
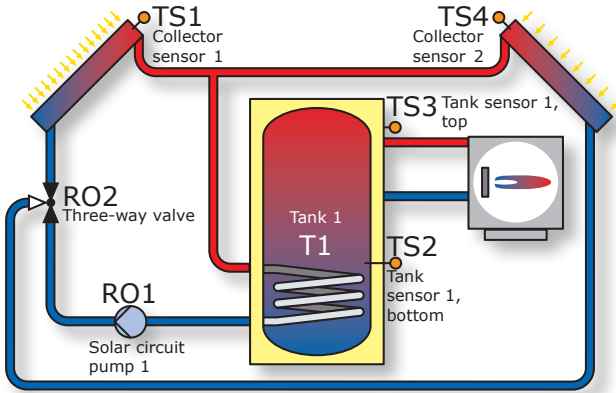

Hydraulic system 18

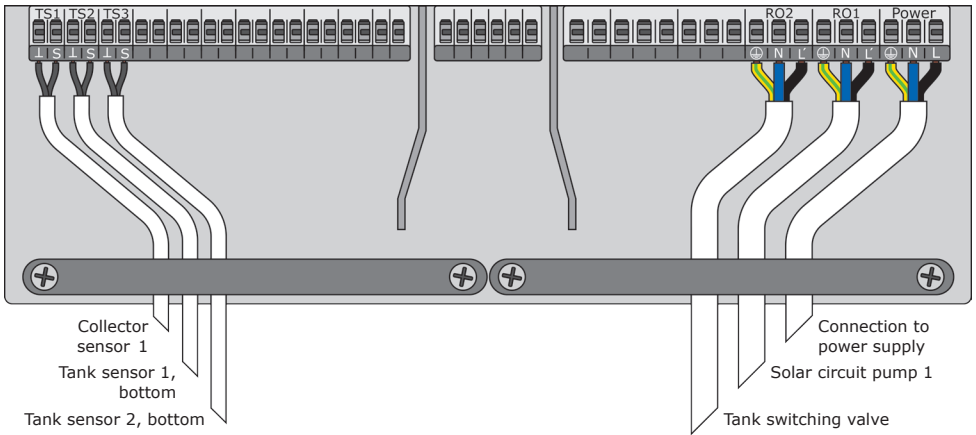
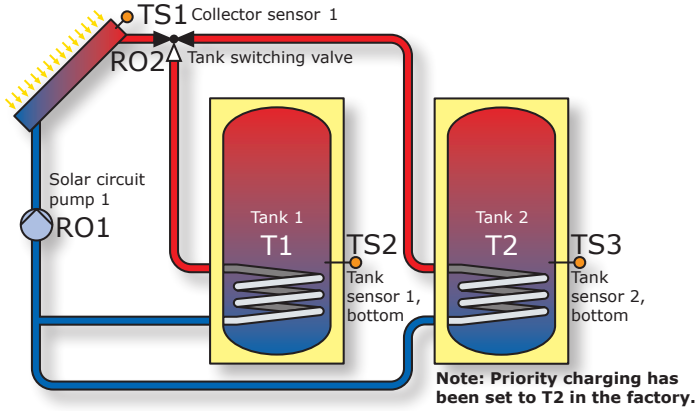

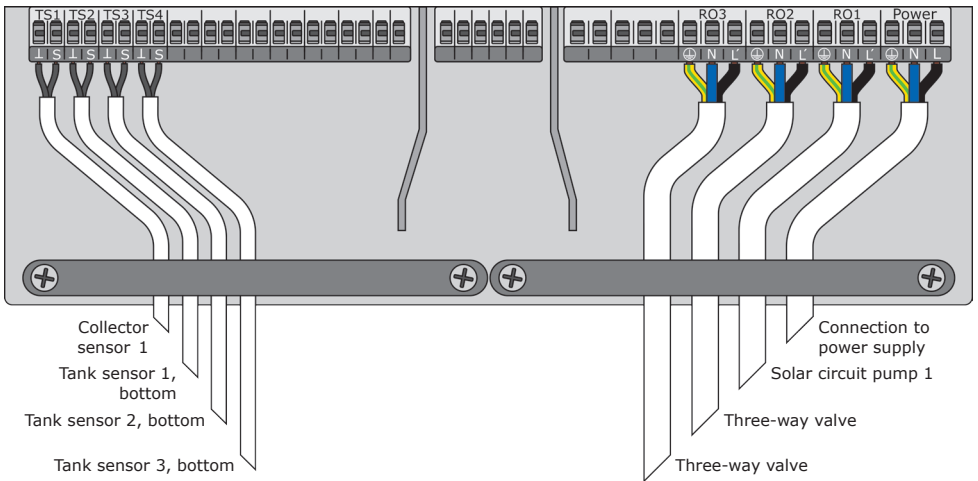
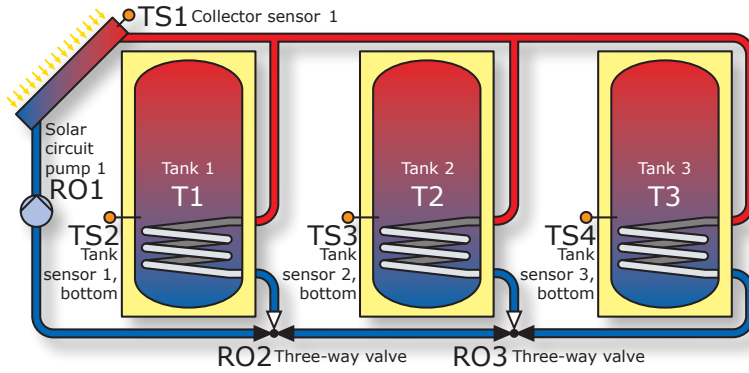

Hydraulic system 20

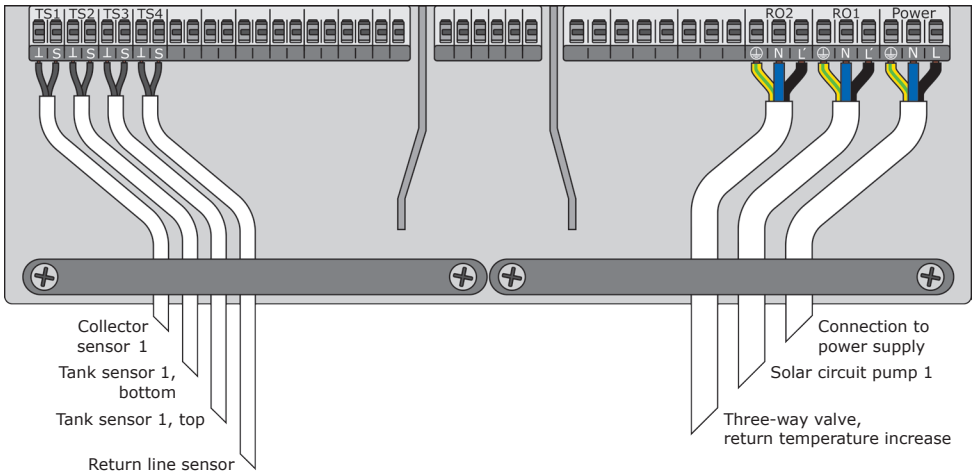
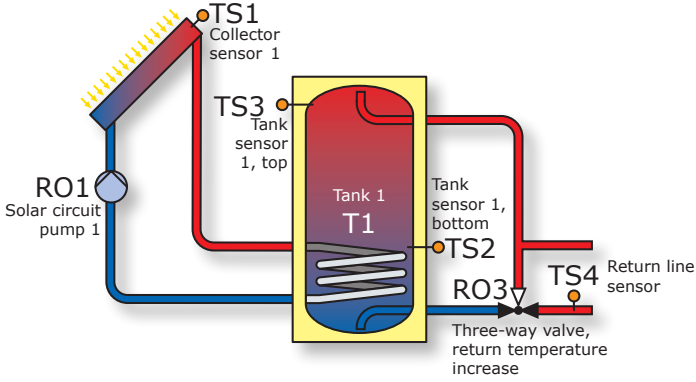

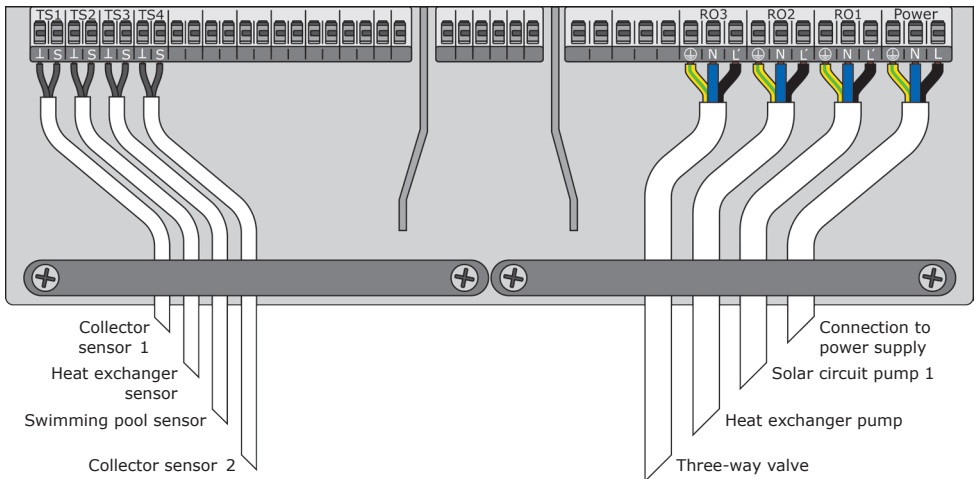
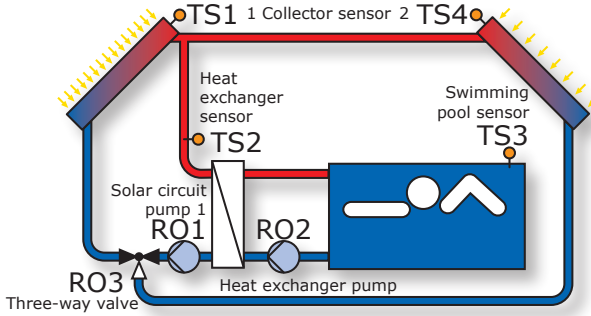

Hydraulic system 22

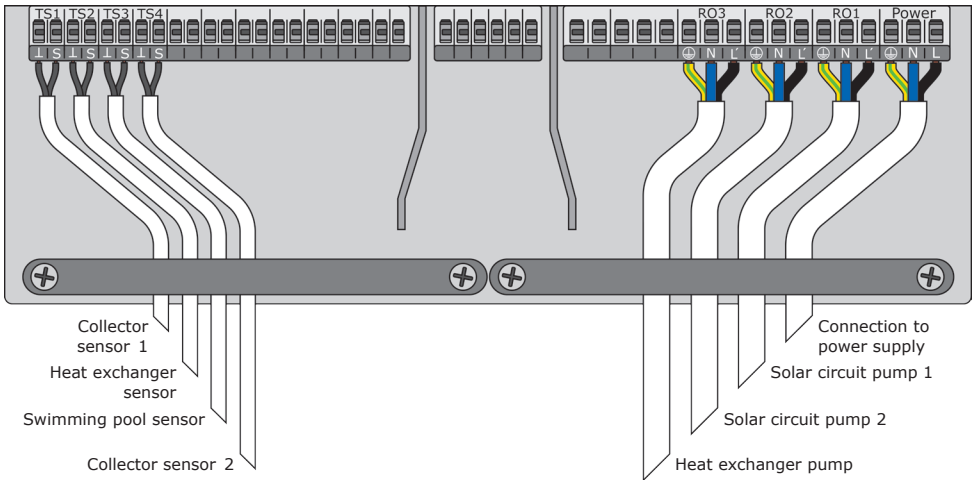
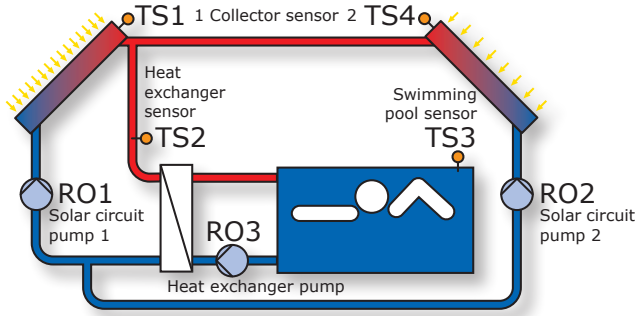

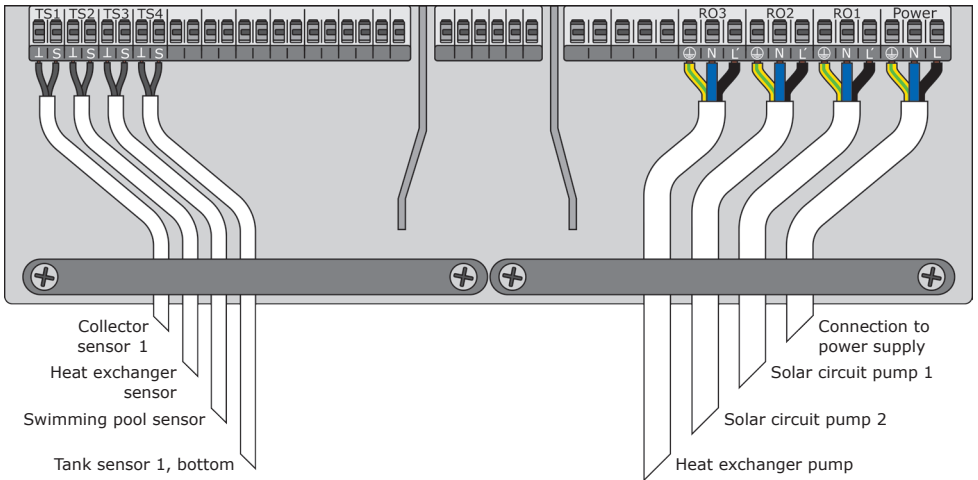
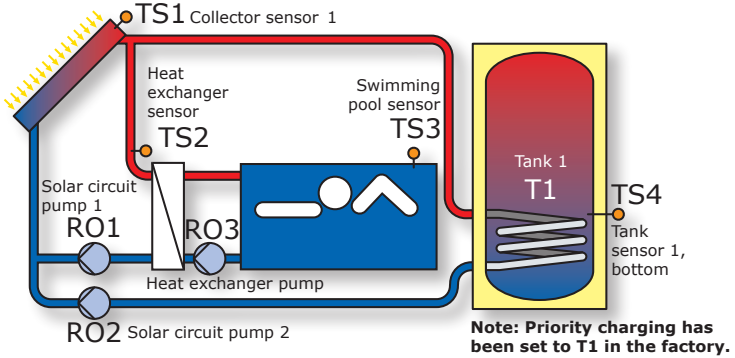

Hydraulic system 24

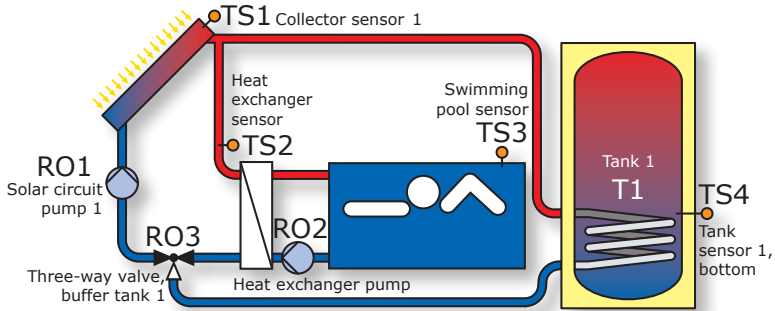

Note: Priority charging has been set to T1 in the factory.

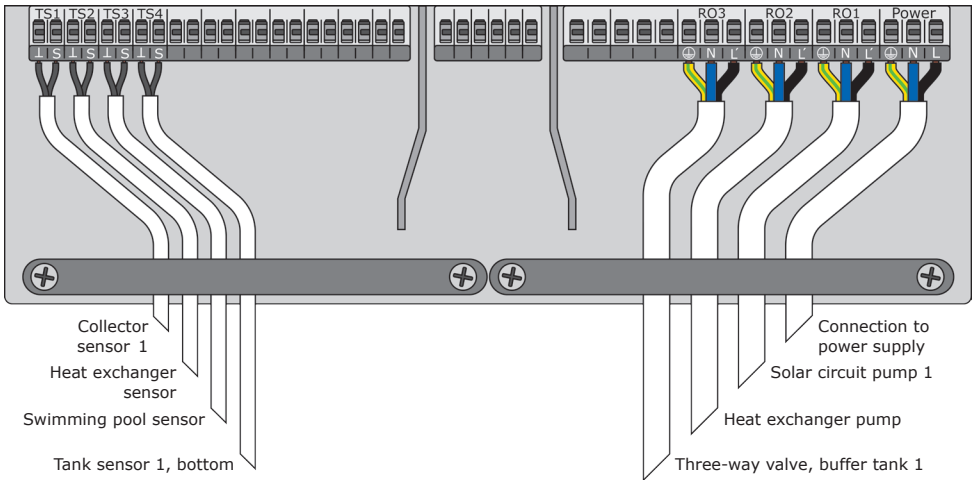

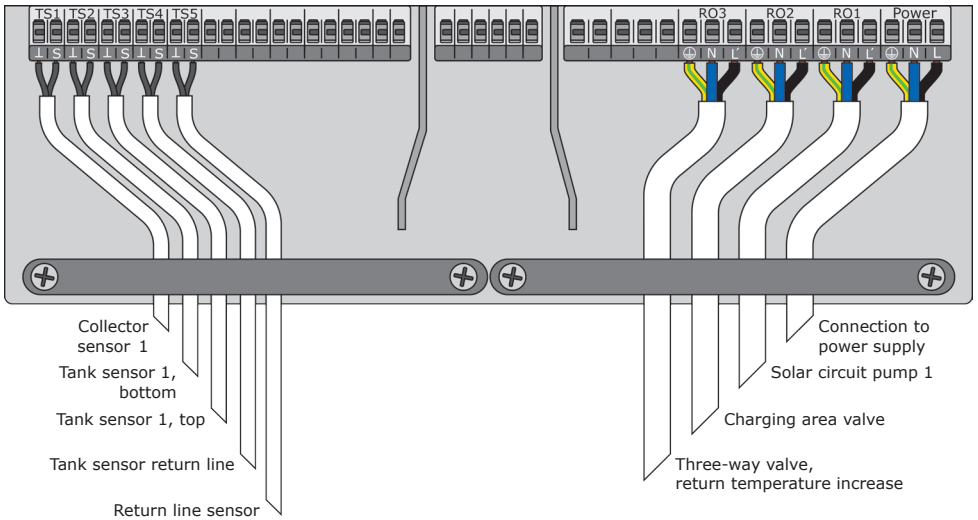
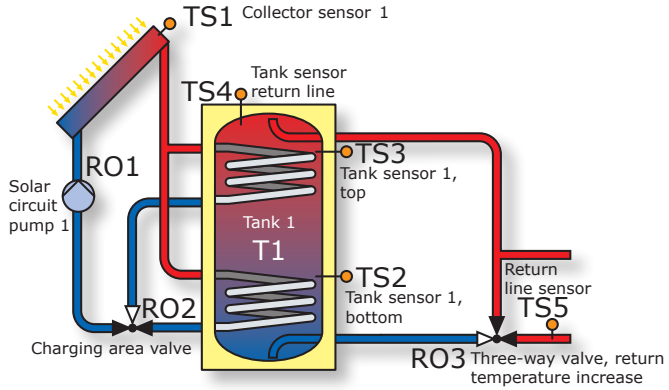

Hydraulic system 26

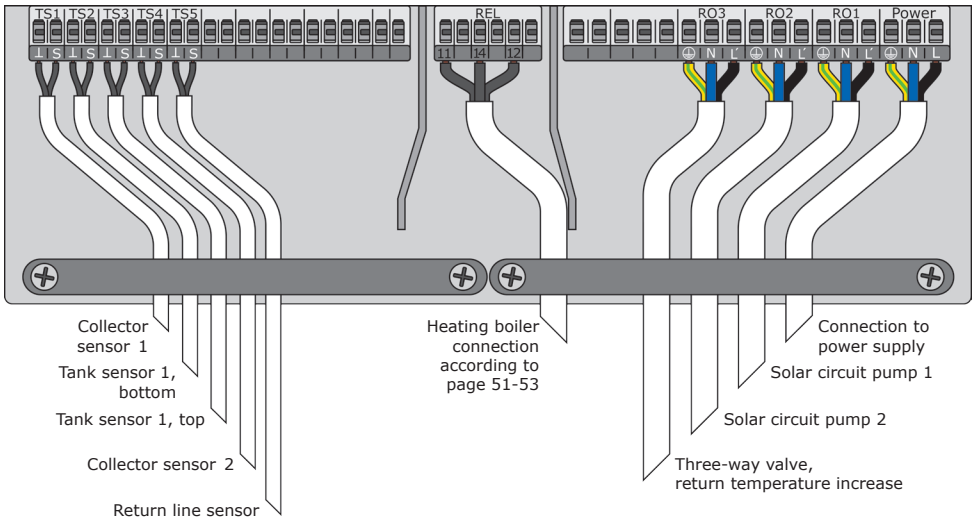
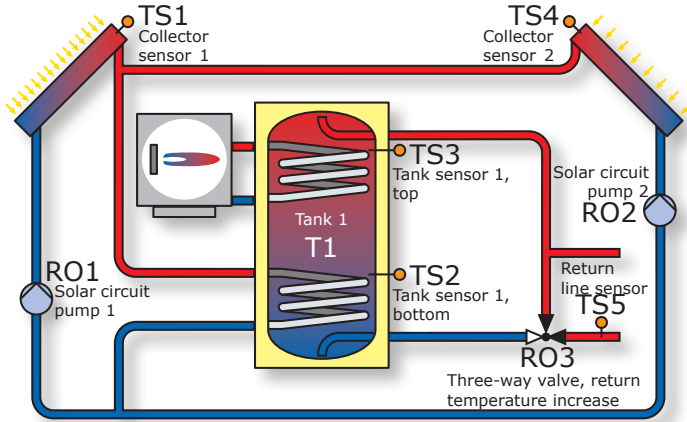

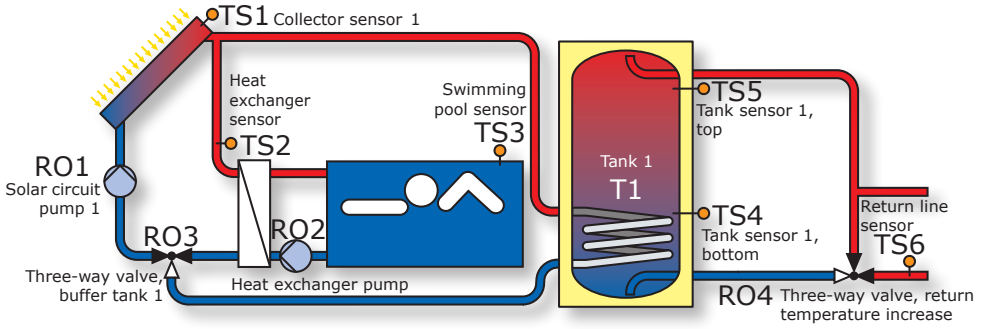

Note: Priority charging has been set to T1 in the factory.

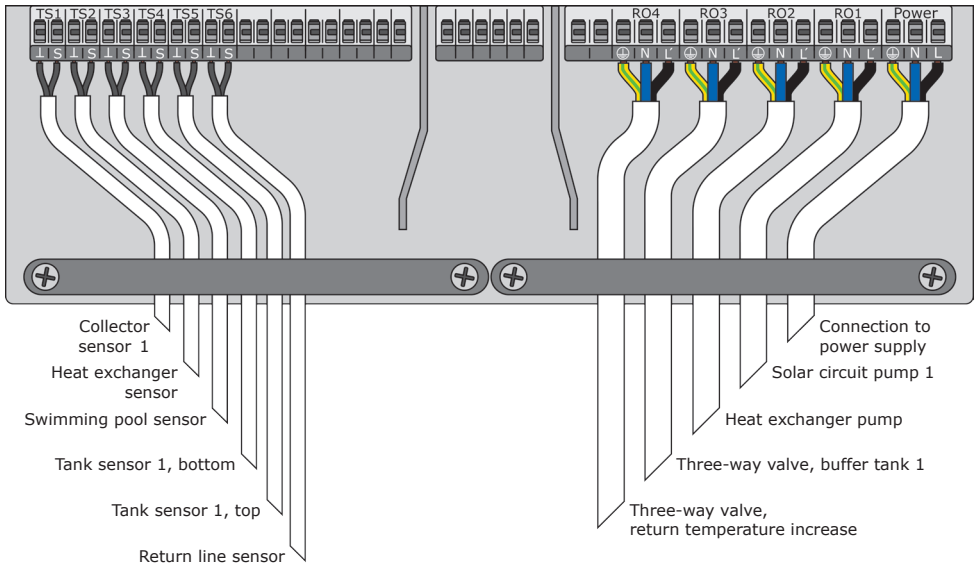

Hydraulic system 28

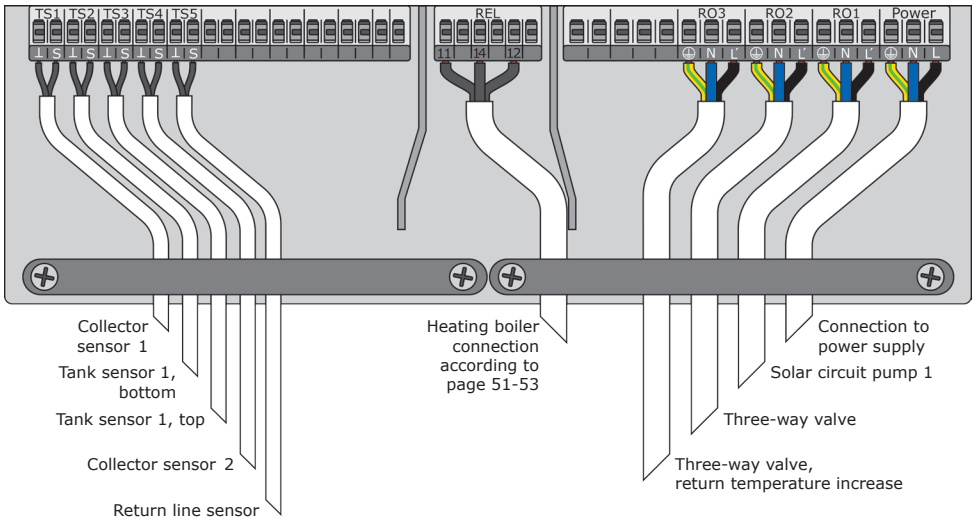
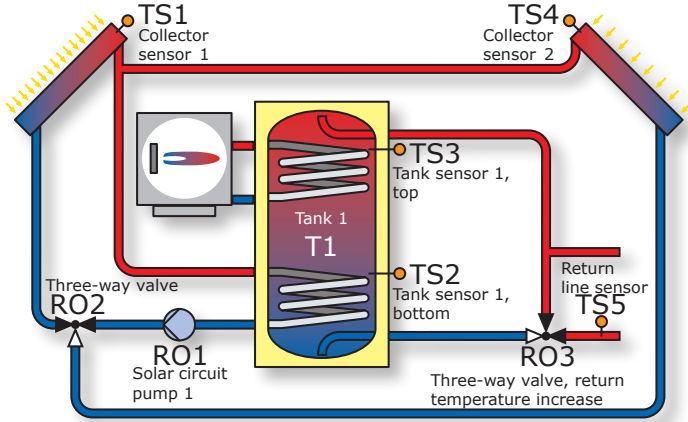

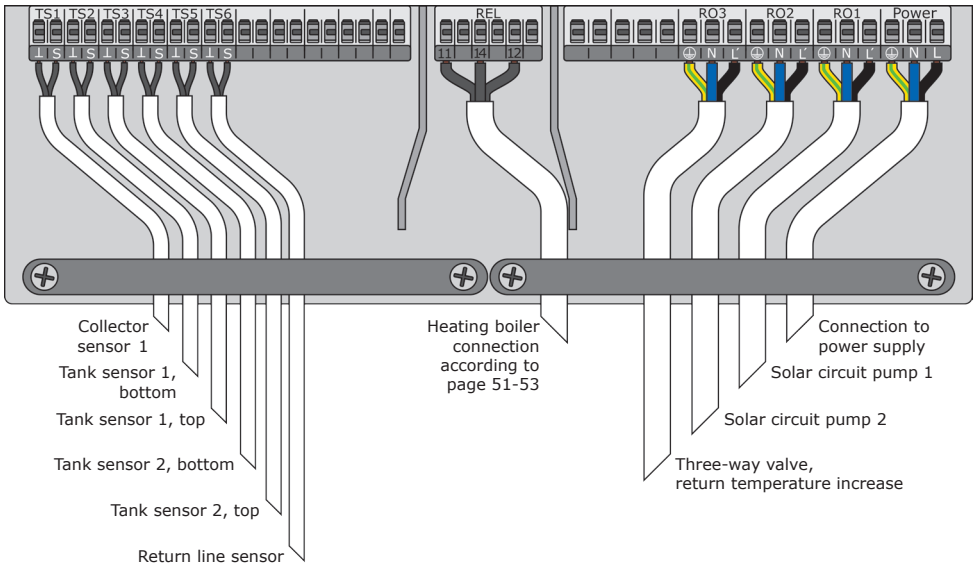
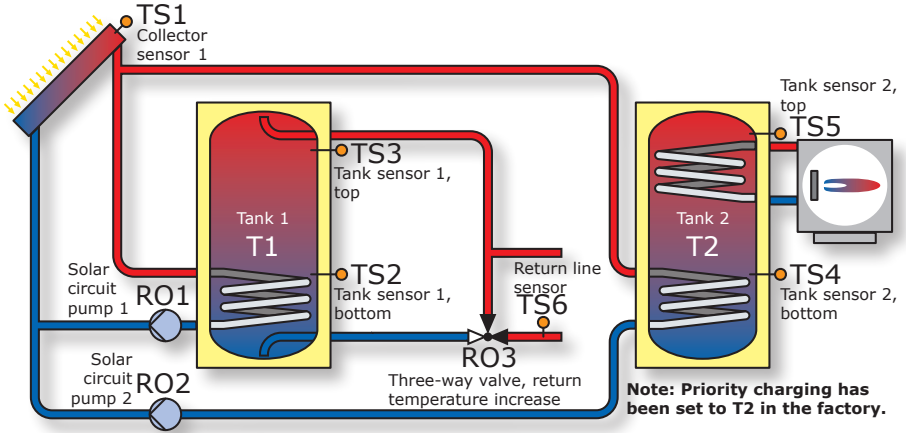

Hydraulic system 30

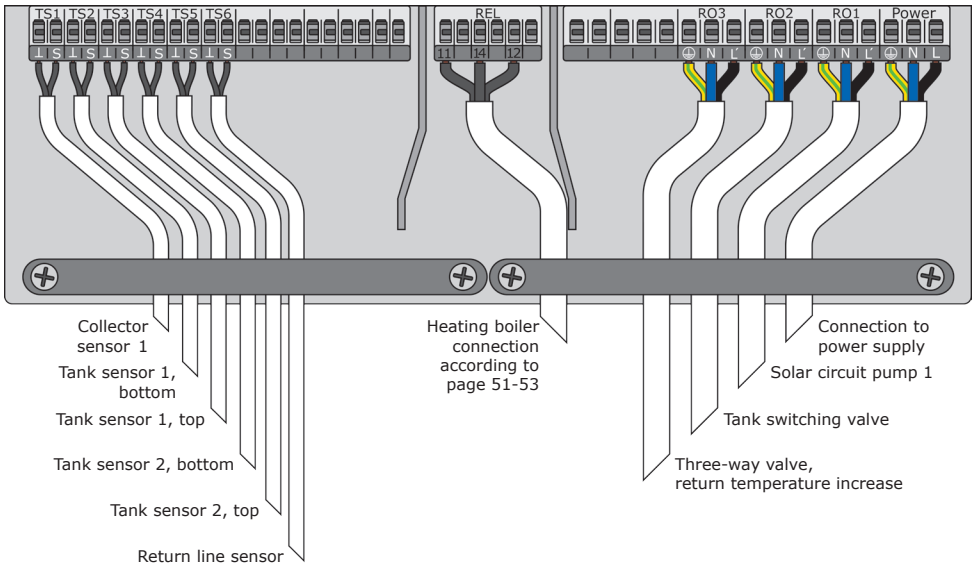
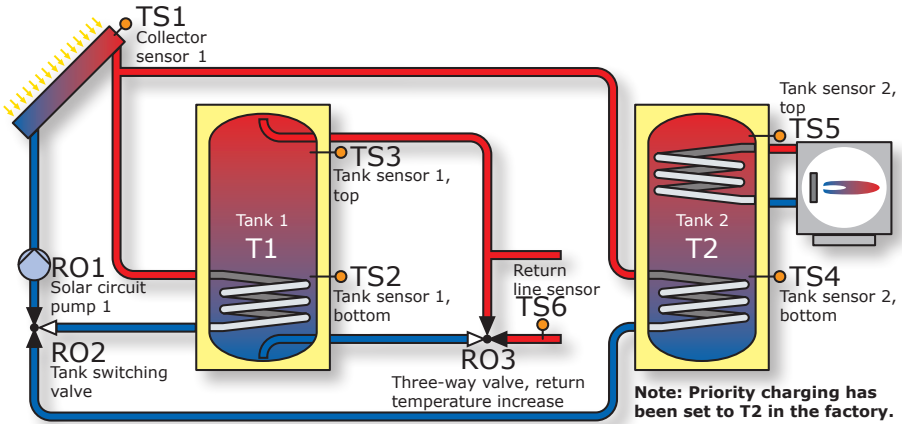

The functions for boiler control are accomplished via the potential-free relay contact which is connected accordingly to the relevant interface of the heating boiler.

The individual functions are assigned the following priorities:

- | | | |
|---|----------------------|------------|
| A | Anti-legionella | priority 1 |
| B | recharge suppression | priority 2 |
| C | reheating | priority 3 |

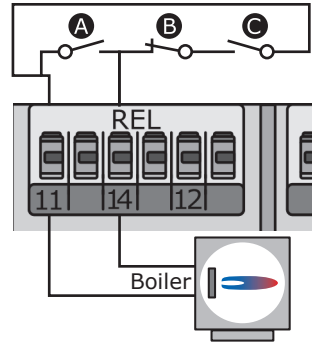

Anti-legionella function

The anti-legionella function checks if the minimum heating for reduction of legionella has been achieved in the tank due to heating activity or solar heat within a set interval. If no sufficient heating has been achieved by these means the controller starts a reheat cycle, specifically for reduction of legionella.

The fitter must set the parameters based on the applicable general directives and local requirements. The time of the disinfection cycle can be determined freely.

Reheat function

The temperature sensor in the upper tank area supplies the values for reheating.

For oil or gas operated systems, reheating takes place via the heating boiler.

For solid-fuel boilers, reheating takes place via the heat present in the drinking water tank. To this effect, the temperature within the tank must be within preset limits.

The temperature control is interlinked with six time blocks.

Reheating is activated as soon as the temperature falls below the set value by the hysteresis value in the current time block. When the set value is exceeded the reheating cycle stops.

Disable recharge

The efficiency of a solar plant increases as the recharge of the tank from the boiler decreases. Consequently, „disable recharge“ means that recharging of the water tank is blocked by the boiler.

Time-controlled disable recharge

Recharge is blocked by the boiler for specific phases via a time program. Within the preset period of time (for ex. 7 to 19 h), recharge is blocked completely by the boiler without requiring the minimum temperature to this effect.

Time-/temperature-controlled disable recharge

If a minimum temperature in the tank is exceeded, disable recharge is activated.

This function can be activated in parallel to the time program.

If the preset minimum temperature (e. g. 45°C) in the tank is exceeded, recharge of the tank is disabled by the boiler.

If, however, the minimum temperature is no longer reached, recharge is enabled by the boiler no matter whether the time program blocks recharge or not.

Efficiency-optimized recharge suppression

If the calculated minimum temperature in the buffer tank is exceeded, the disabled recharge feature is activated. The installer can specify two weighting factors in menu 1.4.3 for the calculation of this minimum temperature:

Factor 1
Solar yield  Parameter values from 1-10 whereby:
1 = more solar yield, less recharge by the boiler
:
10 = less solar yield, more recharge by the boiler

Factor 2
Comfort  Parameter values from 1-10 whereby:
1 = lower comfort, less recharge by the boiler
:
10 = higher comfort, more recharge by the boiler

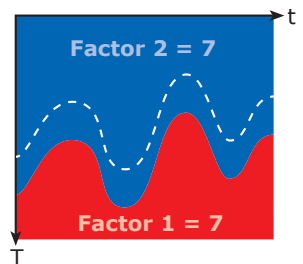
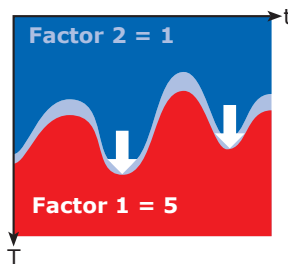
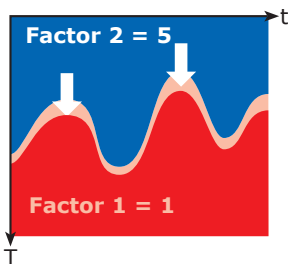
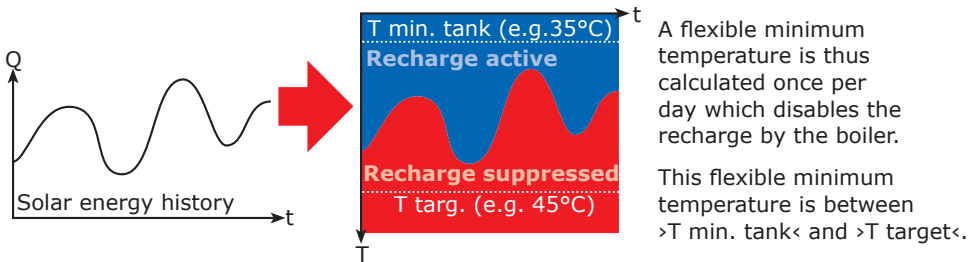



Note!

For boilers without control input, the functions for boiler control can be accessed by the simulation of temperature values.

To enable reheating or anti-legionella functions, the corresponding boiler temperature must be increased at the boiler control.

The differential temperature controller **smart Sol plus** regulates the boiler control functions by a fixed value resistance simulating a charged buffer tank for the boiler.

The resistance value depends on the type of sensor the heating is adjusted to - this information is provided in the boiler manual.

Sensor type	Pt 100	Pt 500	Pt 1000
R Terminal 12	130 Ω	620 Ω	1,3 k Ω
Colour code			

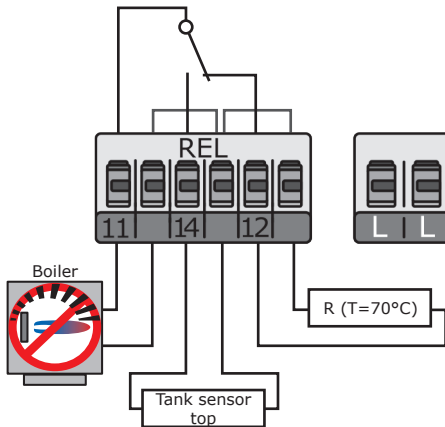

Connection provided at the REL terminal block, as illustrated.

Thermostat functions

The controller's free outputs can be used as thermostats for various applications.

Settings must be made to this effect in professional mode under >1.3.1 Thermostat<.

Control signals can be defined as temperature thermostat, timer, timer thermostat or temperature comparator.

Temperature thermostat >Heating<:

$T_{OFF} > T_{ON}$ The output is deactivated once the > T_{OFF} < temperature is reached, and activated once the > T_{ON} < temperature is reached.

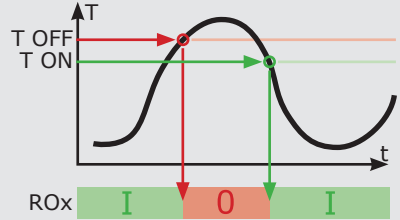

Temperature thermostat >Cooling<:

$T_{ON} > T_{OFF}$ The output is activated once the > T_{ON} < temperature is reached, and deactivated once the > T_{OFF} < temperature is reached.

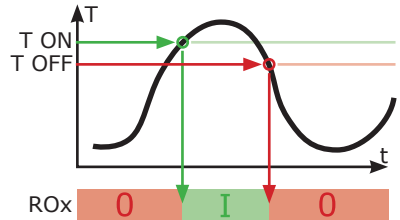

Timer function:

The output is activated within a selected time frame.

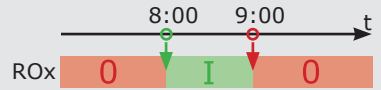

Timer-Thermostat

Combination of timer and thermostat. Once at least one of these criteria is met, the output is activated.

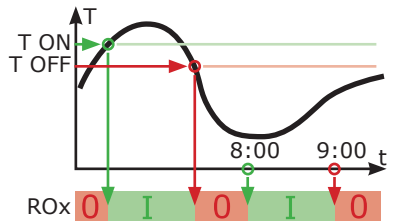

Temperature comparator

Any temperature difference to a reference sensor will trigger a control signal: The output is activated once > dT_{ON} < is reached, and deactivated once > dT_{OFF} < is reached.

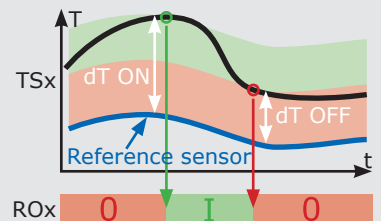

Soft water station AQA solar

In a specific equipment version (with an extension module), the differential temperature controller **smart Sol plus** can be connected to the soft water station AQA solar of BWT Wassertechnik GmbH, Schriesheim.

AQA solar is a decalcification plant based on an ion exchanger, which ensures that the water lines and heat exchangers in your home are not damaged by scaling.

In case of very intense temporary heating of the drinking water, especially with thermal solar systems, decalcification is very useful to maintain efficiency.

Setup and operation of the equipment combination **smart Sol plus** and AQA solar is described in separate documentation and/or the operating manual of BWT.

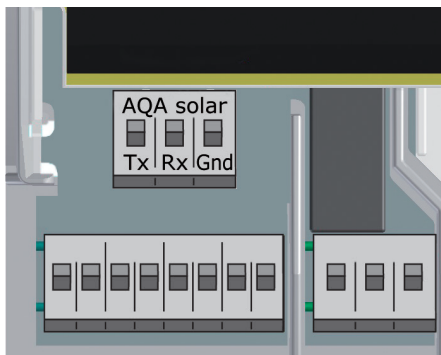

For connection, the terminals >Tx<, >Rx< and >Gnd< above the interface terminals TS1 to TS10 are provided on the extension modules.

Integration of the soft water station is possible in all hydraulic systems of the **smart Sol plus**, and is displayed, e. g.:

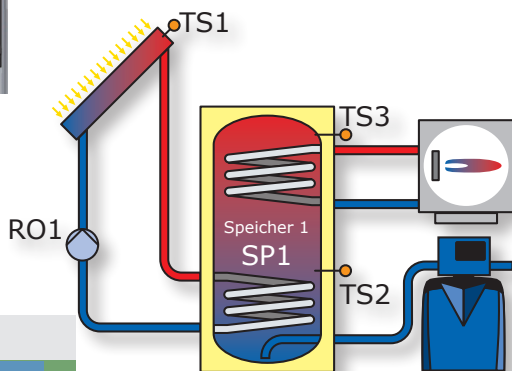

1.8 AQA solar	
Soft water	<input checked="" type="checkbox"/>
Flow rate	421l/h
Soft water delivery	317m3
recent regeneration	24.08.2012 09:00
Salt consumption	66g
25.08.2012	10:30

In the main menu, information transmitted by the soft water station can be retrieved under >1.8 AQA solar<.

Important!

For commissioning, the controller must be assembled correctly, all inputs and outputs must be connected and ready for operation, the strain relief device must be screw-fastened and the terminal cover closed!

This is an explanation in terms of an example of commissioning of the differential temperature controller **smart Sol plus**; details vary along with the hydraulic configuration and the software version.

Commissioning is communicated in plain text; the user must make a selection, acknowledge and - if applicable - jump to the next menu item.

The differential temperature controller **smart Sol plus** accompanies you during the entire configuration and interrogates everything it must know for optimum operation.

Now, the power supply of the controller must be switched on - the display screen appears.



>0.1 Language< appears after a short booting sequence.

Various languages are available in this version of the **smart Sol plus**.

Activate the required version and acknowledge by pressing >Next<.

>0.2 Time/date< appears.

Press >OK< - the hour is highlighted in colour.

Turn the rotary encoder until the correct figure appears, and acknowledge via the >OK< button.

The controller accepts the value and jumps to the minute setting.

In this way, all values for time and date can be entered.

If the differential temperature controller is installed at a location where daylight-saving time exists, the time shift can be activated here.

Acknowledge by pressing >Next<.

0.2 Time/Date	
Date	25.08.2012
Time	09:12
Automat. Clock Change	<input checked="" type="checkbox"/>
	Next
25.08.2012	09:12

>0.3 Inputs< appears.

Select and activate the input interfaces TS1 to TS8 used and assign the selected function to them by scrolling.

Once all inputs have been assigned correctly, acknowledge by pressing >Next<.

0.3 Inputs	
TS1	77.6°C
	Collector 1
TS2	46.7°C
	Tank1 bottom
TS3	42.2°C
	Tank2 bottom
TS4	61.4°C
25.08.2012	09:12

Important!

At the interfaces TS6 / TS7 / TS8 an impeller sensor can be selected as flowmeter via >Impeller<.

0.4 Volumetric flow	
Vortex UI12	<input checked="" type="checkbox"/>
Flow rate	
Grundfos 1-12l/min	
connected to	RO2
	Next
25.08.2012	09:13

>0.4 Volumetric flow< appears.

If TS6 / TS7 / TS8 has already been assigned to >Impeller<, >Impeller< will appear here in terms of sensor system. The number of pulses per litre still has to be selected.

If different features (or no features) are assigned to TS6 / TS7 / TS8, a vortex sensor or a flow rate detector can be selected via pump activation. To this effect, the vortex volumetric flow sensor installed or the max. pump flow rate still have to be defined.

Acknowledge by pressing >Next<..



Important!

A high-efficiency pump can be connected to TS7 to TS10.
The WILO ST 25/7 PWM is preassigned.



0.5 Outputs	
RO1	Solar pump 1
HE-control signal	---
RO2	---
RO3	---
RO4	---
REL	---
	Next
25.08.2012	09:13

>0.5 Outputs< appears.

Select and activate the output interfaces RO1 - RO4 / REL used and assign them to the selected function by scrolling.

Once all outputs have been assigned correctly, acknowledge by pressing >Next<.

Now, the controller offers the hydraulic systems which are possible due to the assigned inputs and the selected outputs.

By turning the rotary encoder, the required system can be selected (here system 1 of 3 possible ones) and acknowledged via the button >OK<.

System 1/3

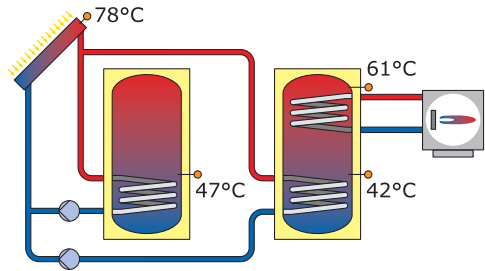

25.08.2012

09:13

Note!

Here, access to all plant layouts is possible for testing purposes via the option >Show all<. However, for correct operation, one of the plant layouts suggested by the controller must be selected.

>0.7 Checklist< appears.

Here, the submenus Test outputs and Holiday function are made available.

By selecting >SP 1 (top), a scrollbox is displayed in which an appropriate input (TS1 - TS8) can be assigned.

Select Test outputs and activate by pressing the OK button.

0.7 Checklist

Test outputs

Holiday function

Tank 1 top

Next

25.08.2012

09:14

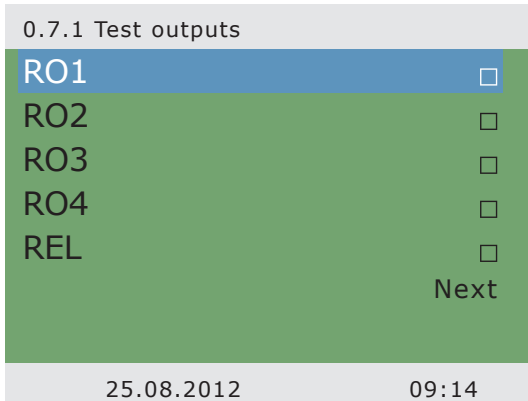

>0.8 Test outputs< appears.

Here, the outputs can be activated manually via the >OK< button to test the function of the activated output or of the connected unit.

If not all pumps and valves are working properly, the plant elements in question and the cabling must be verified and repaired.

Acknowledge by pressing >Next<.

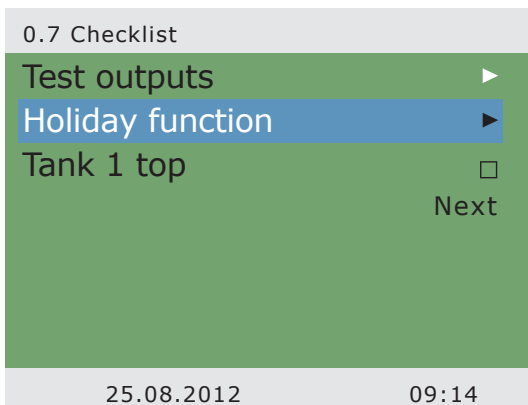

>0.7 Checklist< reappears.

As the plant, when not in use, is only supplied with heat, but no heat is withdrawn, it may be subject to overheating and damage.

Thus, a >holiday function< was programmed which minimizes heat input.

Here, the holiday function can be set - call up by pressing the >OK< button.

Commissioning mode

Various options can be selected for the holiday function.

At lower ambient temperatures (e. g. at night), tank recooling tries to dissipate heat via the collectors.

The soft charge circuit is designed so that the heat input into the tank is as low as possible.

The appropriate switch-ON and OFF temperatures must be varied as required.

Acknowledge by pressing >Next<.

>0.7 Checklist< reappears.

Acknowledge by pressing >Next<.

>0.9 End< appears.

By >Next<, the controller changes over to >Automatic mode<.

Commissioning is complete.

As of this point, the **smart Sol plus** controls the solar thermal plant automatically.

0.7.2 Holiday function

Tank recooling

Soft charge

T-ON 120.0°C

T-OFF 100.0°C

Next

25.08.2012

09:14

0.9 End

You have completed commissioning!

Next

25.08.2012

10:15

System 11

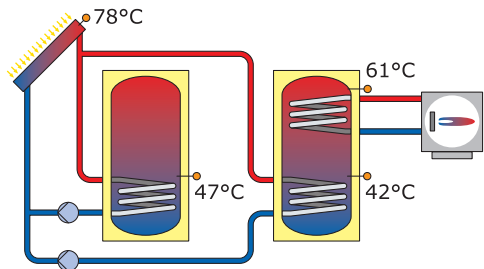

25.08.2012

09:16

System 11

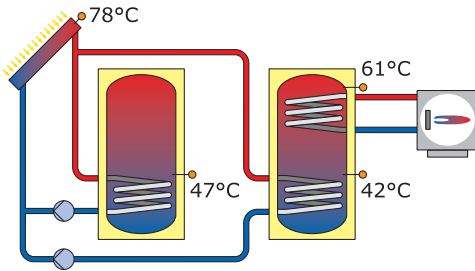

25.08.2012

09:17

In automatic mode, the screen displays the date, the time and the active hydraulic system.

The current temperature is displayed for each temperature sensor.

The pump activity is displayed on the display as animation.

There is no need for intervention by the fitter or operator.

Note!

Check the display screen of the **smart Sol plus** on a regular basis to be able to eliminate any malfunctions promptly!

Operation mode

On the controller, the user can make various settings and obtain information about states and processes.

To this effect, press the button >OK< in automatic mode.

System 11

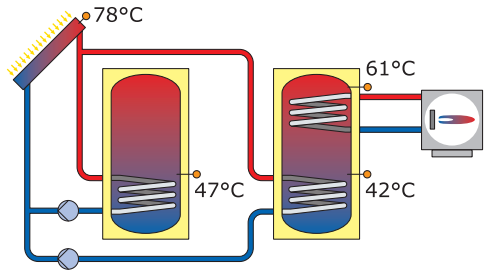

25.08.2012

10:19

>1 Main menu< appears.

A list of subitems appears

By scrolling ...

1 Main menu

Evaluation ▶

Settings ▶

Basic functions ▶

Efficiency functions ▶

Protective funct. ▶

Monitoring ▶

Login ▶

25.08.2012

10:19

...the lower part of the menu is displayed.

Once the first subitem

>Evaluation< is selected, ...

1 Main menu

Settings ▶ ▲

Basic functions ▶

Efficiency functions ▶

Protective funct. ▶

Monitoring ▶

Login ▶

About smartSol ▶

25.08.2012

10:19

1.1 Evaluation	
Measured values	▶
Service hours	▶
CO2 savings	▶
Heat quantities	▶
Error list	▶
25.08.2012	10:20

...>1.1 Evaluation< appears.
 Another selection level appears.
 Once the first subitem
 >Measured values< is selected, ...

1.1.1 Measured values	
Collector temperature1	78.2°C
Tank 1 bottom temp.	47.0°C
Tank 2 bottom temp.	42.1°C
Tank 1 top temp.Solar	61.4°C
Solar pump 1	80%
Solar pump 2	34%
Boiler	OFF
25.08.2012	10:20

...>1.1.1 Measured val...< appears.
 Here, the temperatures and
 dates concerning the controller
 are displayed.
 If additional tank sensors have
 been defined on commissioning,
 these measurands also appear here.
 Return to >1.1 Evaluation<.
 Once the second subitem
 >Service hours< is selected, ...

1.1.2 Service hours	
Solar pump 1	112h
Solar pump 2	94h
Boiler	361h
Reset	
25.08.2012	10:21

...>1.1.2 Service hours< appears.
 The operating time of the activated
 plant components is displayed in
 hours.
 By actuating the menu item >Reset<,
 all counters are reset to zero.
 The values are saved once per day,
 so that one day max. is „lost“ in
 case of failure of the power supply.
 Return to >1.1 Evaluation<.
 Once the third subitem
 >CO2 savings< is selected, ...

...>1.1.3 CO2 savings< appears.

Here, assessment of the saved carbon dioxide can be activated, read and reset.

By selecting >Fuel<...

1.1.3 CO2 savings

Activation

CO2 Savings (calc.) 447 kg

Reset

Fuel Natural gas

25.08.2012 10:21

...>Edit< appears.

Here, the fuel types natural gas or fuel oil can be selected for a calculation of CO₂.

Return to >1.1 Evaluation<.

Continue with >Heat quantities<.

Edit

Fuel

Natural gas

Restore last value

Factory settings

25.08.2012 10:15

>1.1.4 Heat quantities< appears.

Up to four heat counters can be configured for the collection of the generated energy quantity.

The evaluation period can be selected via the >Diagram< - >Week<, >Month< or >Year<

Press >Reset< to reset the counter to 0.

1.1.4 Heat quantities

Heat qty. 1 ▶

Heat qty. 2 ▶

Heat qty. 3 ▶

Heat qty. 4 ▶

Diagram Week

Reset

25.08.2012 10:22

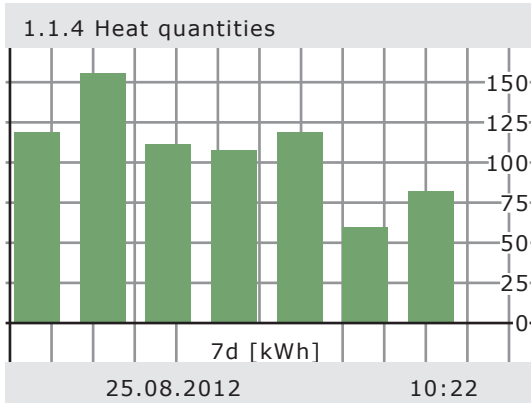

The evaluation graph appears as a bar graph.

Selecting a submenu, e.g. >Heat qty. 1<...

1.1.4.1 heat qty. 1

Activation

Heat quantity (calculated) 0 kWh

Volume flow ---

Return line sensor ---

Supply line sensor --- ▼

25.08.2012 10:22

...will access >1.1.4.1 heat qty. 1<

Activation will start a counter which calculates heat yield.

>Volume flow< defines the volume flow sensor to be used.

Return and feed sensors are assigned.

1.1.4.1 heat qty. 1

Return line sensor --- ▲

Supply line sensor ---

Glycol type Water

Efficient tank-charge

Add to overall HQ

25.08.2012 10:22

In addition to the operation mode's functions, the sensors in the return and supply lines are assigned.

>Efficient tank-charge< defines whether this heat quantity is used for efficient buffer charge.

>Add to overall HQ< adds each heat quantity to the overall counter.

Continue with >Error list<.

>1.1.5 Error list< appears.

Here, a table of the last errors occurred appears for information.

By selecting a fault ...

1.1.5 Error list	
M33: 4:31	03.07
M32: 6:44	03.07
M05: 7:01	03.07

25.08.2012	10:22

... the error message appears in plain text.

If necessary, take the appropriate measures.

Return to >1 Main menu<.

Continue with >Settings<.

1.10 Error list	
M05:	Sensor short-circuit on TS3!
Press ESC to return	
25.08.2012	10:22

>1.2 Settings< appears.

Another selection level appears.

Once the first subitem >Date/Time< is selected, ...

1.2 Settings	
Date/Time	▶
Language	▶
Display	▶
Remove SD card safely	
Factory settings	
25.08.2012	10:23

1.2.1 Date setting

Date	25.08.2012
Time	10:23
Automat.Clock Change	<input checked="" type="checkbox"/>

25.08.2012 10:23

...>1.2.1 Date settings< appears.

Here, date and time can be set in case of deviation or an extended period of deenergizing.

If the differential temperature controller is installed at a location where daylight-saving time exists, the time shift can be activated here.

Select the subitem >Date< or >Time< by pressing >OK<.

1.2.1 Date setting

Date	25.08.2012
Time	10:23
Automat.Clock Change	<input checked="" type="checkbox"/>

25.08.2012 10:23

One group of figures each is activated and can be varied via the rotary encoder; whenever >OK< is pressed, the activation jumps to the next group.

Return to >1.2 Settings<.

Continue with >Language<.

1.2.2 Language

Deutsch	<input checked="" type="checkbox"/>
English	<input type="checkbox"/>
Français	<input type="checkbox"/>
Italiano	<input type="checkbox"/>
Česky	<input type="checkbox"/>
Español	<input type="checkbox"/>
Polski	<input type="checkbox"/>

25.08.2012 10:23

>1.2.2 Language< appears.

Here, the user can change over to another available language.

Continue with >Display<.

>1.2.7 Display< appears.

>Brightness< serves to adjust the backlighting of the display in steps of 5% from 10% to 100%.

>Blanking time< is used to determine the time after which, in case of inactivity, backlighting is reduced from the set value to 10%. Adjustable in the range from 30 to 255 seconds.

Return to >1.2 Settings<.

Before the SD card can be removed, >Remove SD card safely< must have been selected.

The last menu item is >Factory settings<.

By selecting and pressing the button >OK<, followed by >esc<, the preset values are deleted and replaced by the factory settings.

Return to >1 Main menu<.

Continue with >Basic functions<.

>1.3 Basic functions< appears.

Another selection level appears.

Once the first subitem >Thermostat< is selected, ...

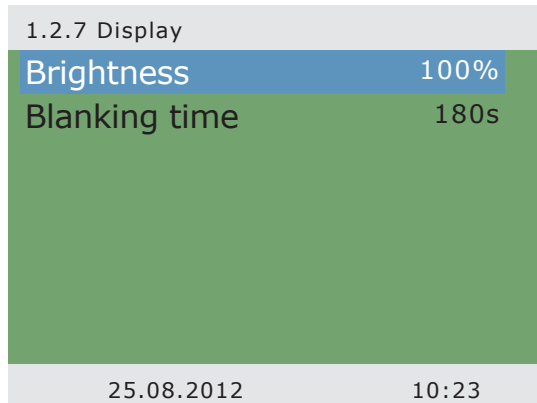

1.2.7 Display

Brightness	100%
Blanking time	180s

25.08.2012 10:23

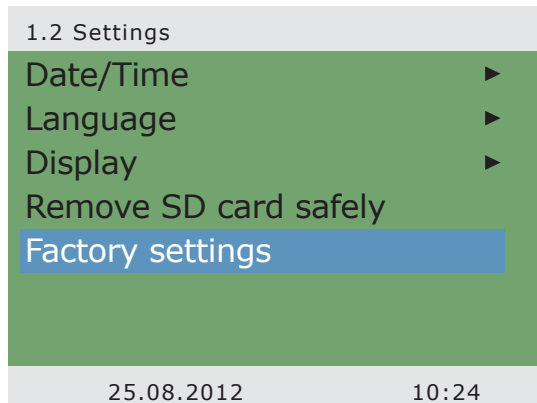

1.2 Settings

Date/Time	▶
Language	▶
Display	▶
Remove SD card safely	
Factory settings	

25.08.2012 10:24

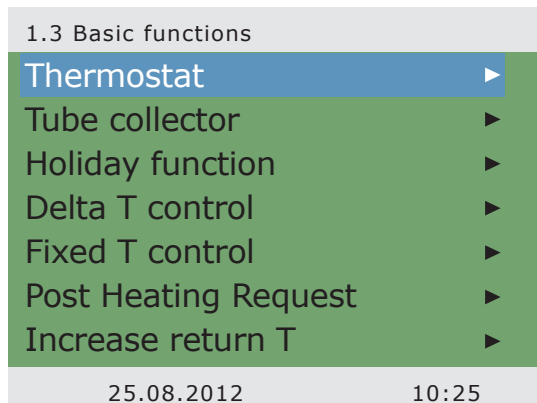

1.3 Basic functions

Thermostat	▶
Tube collector	▶
Holiday function	▶
Delta T control	▶
Fixed T control	▶
Post Heating Request	▶
Increase return T	▶

25.08.2012 10:25

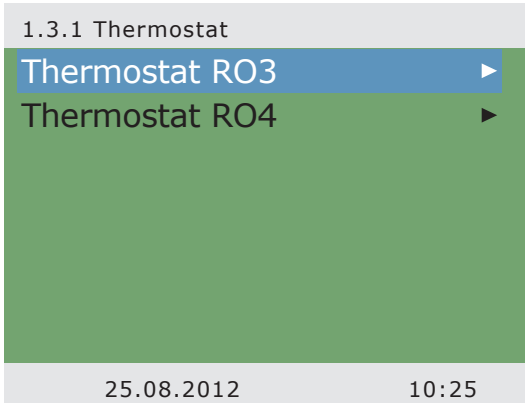

...>1.3.1 Thermostat< appears.

The controller's free outputs can be used as thermostats for various applications.

In professional mode, presettings must be made to this effect - your fitter will explain the appropriate function to you, if necessary.

By selecting a subitem ...

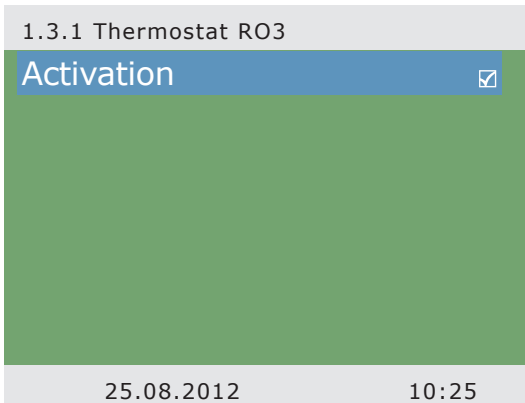

...the appropriate activation screen is displayed.

Return to >1.3 Basic functions<.

Continue with >Tube collector<.

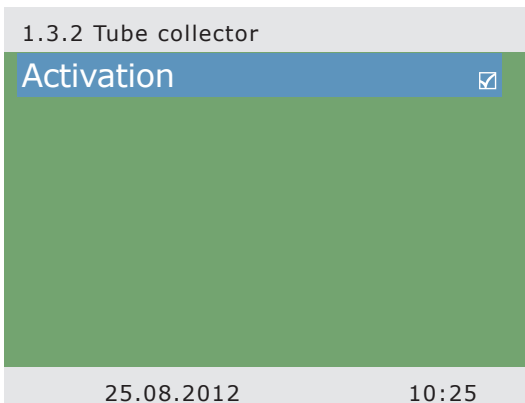

>1.3.2 Tube collectors< appears.

This option is to be activated in case vacuum tube collectors are used.

Return to >1.3 Basic functions<.

Continue with >Holiday function<.

>1.3.3 Holiday funct...< appears.

Here, you enter the time of your next holiday. "Holiday" means that the heating/
warm water plant is not used in summer.

In this case, the controller will adapt control for the specified period so that overheating of the plant is prevented.

First select the subitem >Start<, then >End< by pressing >OK<.

1.3.3 Holiday function

Start of holiday	19.07.2013
End of holiday	02.08.2013

25.08.2012 10:26

>Edit< appears.

Here, the dates of your absence are entered. Return to >1.3 Basic functions<.

Continue with >Delta T control<.

Edit

Start of holiday	19.07.2013
------------------	------------

Restore last value
Factory settings

25.08.2012 10:26

>1.3.5 dT control< appears.

Here, parameters of the controller can be changed.

The factory settings of the **smart Sol plus** can be used for almost all plants.

Ask a fitter before making changes at this point.

Return to >1.3 Basic functions<.

Continue with >Fixed T control<.

1.3.5 dT control

dT-ON 1	8.0k
dT-OFF 1	4.0k

25.08.2012 10:27

1.3.6 Fixed temp.cont...

T-fixed 2	70.0°C
-----------	--------

25.08.2012 10:27

>1.3.6 Fixed temp.c...< appears.

Here, the temperature values for the collector panels are entered which are to be achieved via control of the pump delivery rate in question.

The factory settings of the **smart Sol plus** can be used for almost all plants.

Return to >1.3 Basic functions<.

Continue with >Increase return T<.

1.3.8 Increase return ...

Activation	<input checked="" type="checkbox"/>
T ON	8.0K
T OFF	4.0K
T min	15.0°C

25.08.2012 10:27

>1.3.8 Increase retu...< appears.

Parameters for return flow temperature increase can be defined here.

Ask a fitter before making changes at this point.

Return to >1 Main menu<.

Continue with >Post Heating Request<.

1.3.10 Post Heating R...

Hysteresis	10.0K
Time block 1	▶
Time block 2	▶
Time block 3	▶
Time block 4	▶
Time block 5	▶
Time block 6	▶

25.08.2012 10:27

>1.3.10 Post Heatin...< erscheint.

The reheating control reacts to the values of the top tank sensor. If the temperature falls below >t charge< minus the hysteresis, the control activates the reheating cycle via the heating boiler. When the set value is reached the reheating cycle is stopped.

Return to >1 Main menu<.

Continue with >Efficiency functions<.

>1.4 Efficiency funct...< appears.

Another selection level appears.

Once the first subitem

>disable recharge< is selected, ...

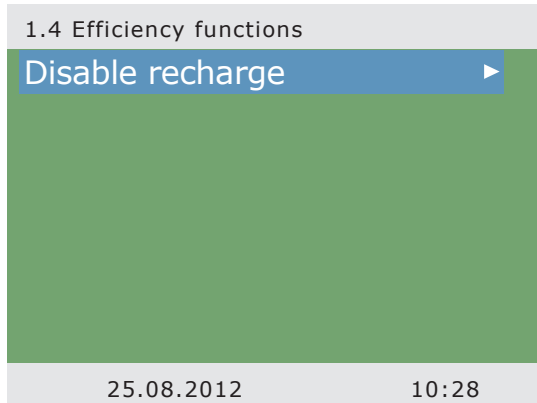

... >1.4.3 disable recha...< appears.

This option must be activated if recharging of the warm water tank is to be switched off as a function of time or temperature.

To this effect, the fitter must make the appropriate presettings.

Return to >1 Main menu<.

Continue with >Protective functions<.

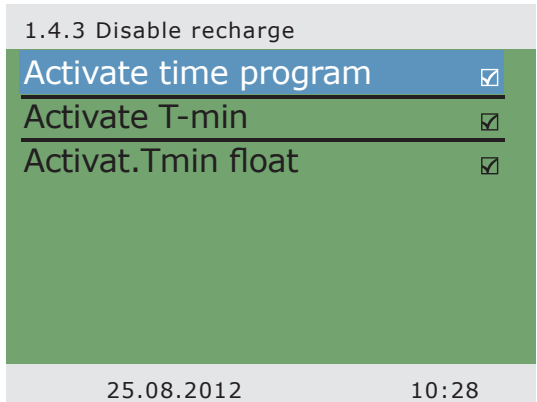

>1.5 Protective funct.< appears.

Another selection level appears.

Continue with >Collector defrost.<.

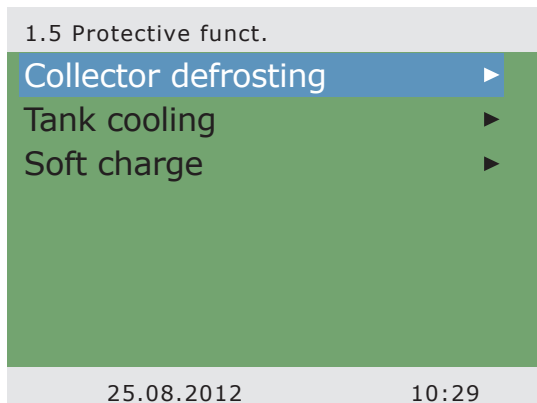

1.5.2 Defrosting

Activation

>1.5.2 Defrosting< appears.

>Defrosting< can be used to heat frozen collectors.

At the same time, the tank is cooled!

This is a one-time action which must be repeated as required.

Return to >1.5 Protective functions<.

Continue with >Tank cooling<.

25.08.2012

10:29

1.5.5 Cooling funct.

Activation

>1.5.5 Cooling funct.< appears.

This option must be activated if, during a heat wave, the heat input exceeds the energy withdrawal.

In this case, the controller cools the tank via the collectors, e. g. at night.

Return to >1.5 Protective functions<.

Continue with >Soft charge<.

25.08.2012

10:29

1.5.6 Soft charge

Activation

>1.5.6 Soft charge< appears.

This option should be activated if an extended spell of hot, sunny weather is to be expected. Thus, the heat input in the tank is reduced.

Return to >1 Main menu<.

Continue with >Monitoring<.

25.08.2012

10:29

>1.6 Monitoring< appears.

Here, the error list can be called up.
The required information appears on the display.

Return to >1 Main menu<.

Continue with >Login<.

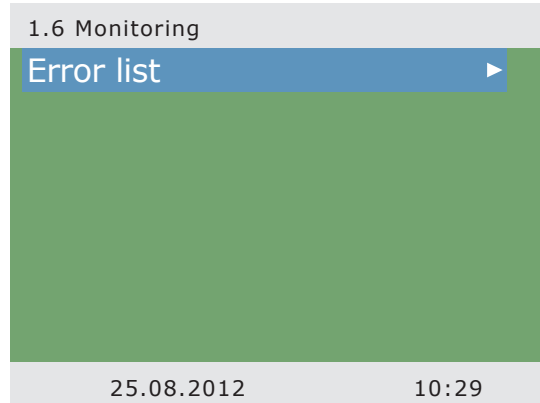

>1.7 Login< appears.

Here, the fitter can enter his/her access code to perform further settings and changes.

Return to >1 Main menu<.

Continue with >AQA solar<.

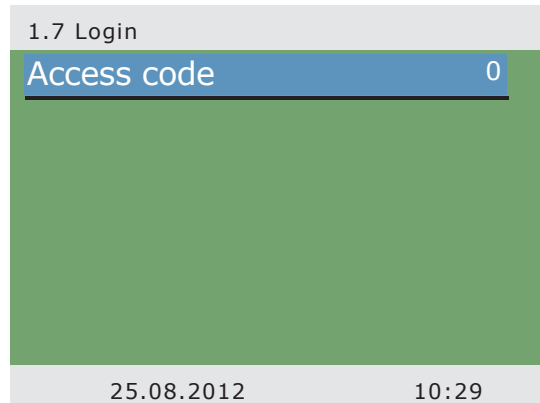

>1.8 AQA solar< appears.

This menu is only occupied if the soft water station >AQA solar< made by BWT is integrated in the fresh water heating.

For appropriate information, please refer to the documentation by BWT / regarding AQA solar.

Return to >Main menu<.

Continue with >About **smart Sol**<.

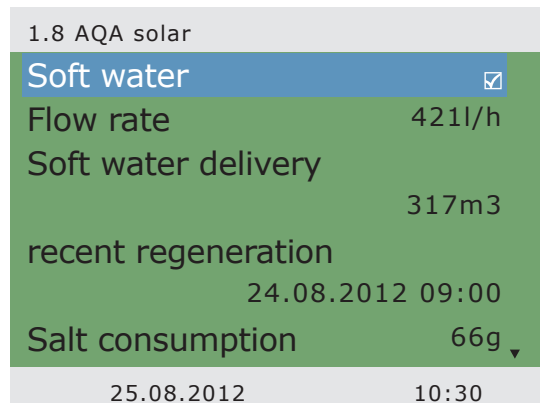

1.9 About

smartSol

SW version	11.42
HW version	3.01
Serial number	16009
Commissioning	24.08.2012

25.08.2012

10:30

>1.9 About< appears.

Here, the software and hardware version of the controller, the serial number and the date of commissioning appear.

This information is required for repairs and for version management.

System 11

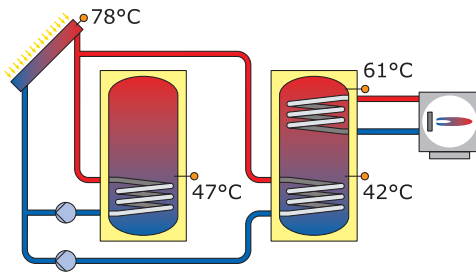

25.08.2012

10:31

If no entry is made within the preset time (30 - 255 s) on the **smart Sol plus**, the display returns to >System<.

>esc< is used to return to the home screen from every menu.

Malfunction

The screen on top right shows the ›Attention‹ symbol which points out a notification or an operating malfunction.

Select via ›OK‹.

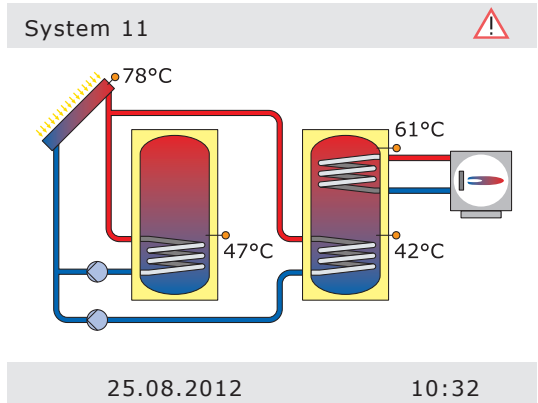

If ›Safety function‹ appears in the display, this is a message, no malfunction.

In this case, there is no deficiency, but limits have been exceeded.

The controller indicates that a protective function has been triggered.

The message is only active until normal operation has been restored.

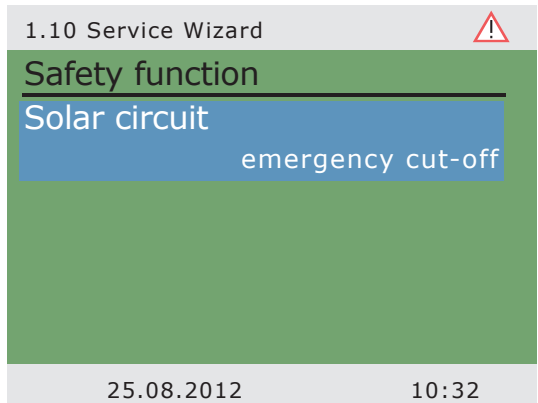

Note!

If a malfunction message appears in the display, the operator can define the possible causes by means of the Service Wizard so that he/she can provide the fitter with precise information.

The differential temperature controller **smart Sol plus** communicates malfunction processes in plain text. The Service Wizard indicates the possible causes of malfunctions on the basis of the detected symptoms and thus supports immediate and comfortable detection of deficiencies.

There may be various deficiencies in a solar thermal system, which require a wide variety of approaches. The controller communicates every step to the operator or fitter via the screen, so that there is no need to describe all malfunctions in detail in this operating manual.

Here, a malfunction message with troubleshooting process is presented as an example.



Danger!

Mortal danger due to electrocution!
For troubleshooting on the plant, disconnect all poles of the power supply reliably and protect it them against being switched on again!



1.10 Service Wizard



M02:
Breakage of
sensor on TS1!

Menu Next

25.08.2012

10:33

>1.10 Service Wizard< appears.

The malfunction appears in plan text - here:

>M02: Breakage of sensor on TS1!<.

If an analysis/repair is not required at present, press >Menu< to return to the main menu.

The Service Wizard helps detect possible causes of malfunctions. Acknowledge by pressing >Next<.

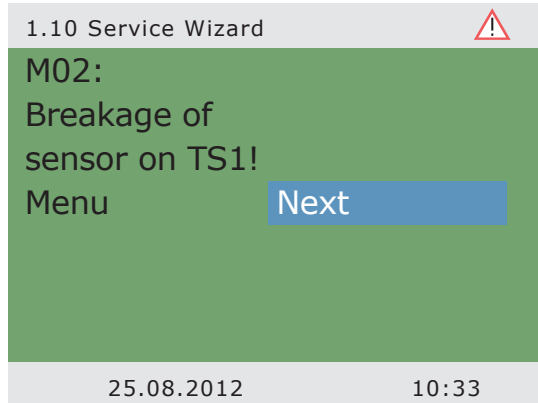

1.10 Service Wizard 

M02:
Breakage of
sensor on TS1!
Menu Next

25.08.2012 10:33

For this malfunction, the following causes are assumed:
>Cable/connection< or >Sensor< -
select the first menu item and confirm by pressing >OK<.



1.10 Service Wizard 

Possible reasons:
Cable/connection
Sensor
Exit

25.08.2012 10:33

The controller here provides the troubleshooting instruction to check the connection cable.

Perform the measure in accordance with the recommendation.

Acknowledge by pressing >Next<.

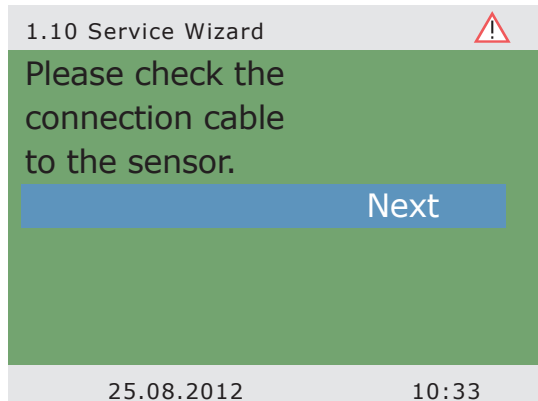

1.10 Service Wizard 

Please check the
connection cable
to the sensor.
Next

25.08.2012 10:33

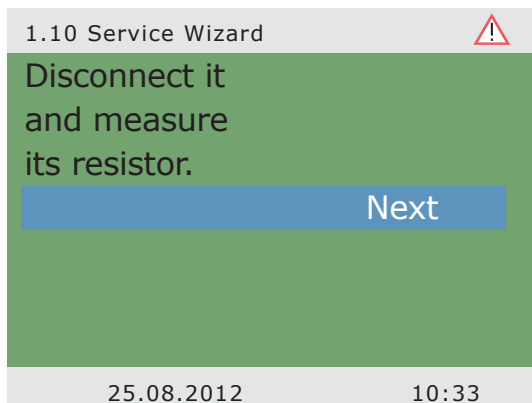

More detailed instructions are available if required.

Acknowledge by pressing >Next<.

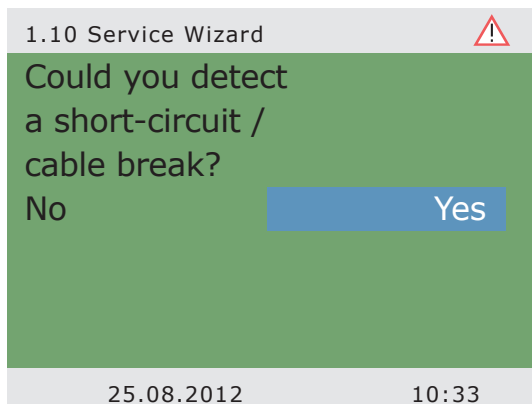

The troubleshooting result is interrogated.

Continue via >Yes< for the case that the malfunction has been determined.

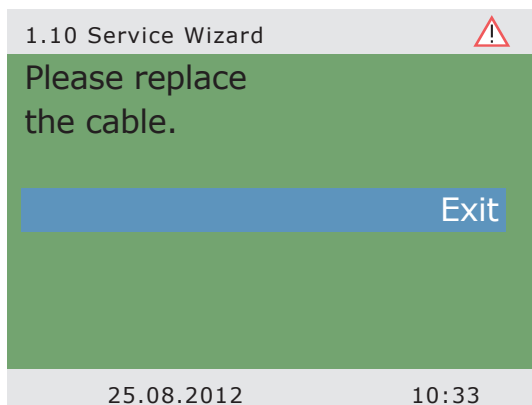

Repair information appears.

Perform the appropriate repair work.

Exit the >Service Wizard< by pressing >Exit<.

If the cause of the malfunction has not yet been determined, troubleshooting can be continued.

Continue with >No<.

1.10 Service Wizard 

Could you detect a short-circuit / cable break?

No Yes

25.08.2012 10:33

Select all the sources of malfunctions listed, and confirm via >OK<.

1.10 Service Wizard 

Possible reasons:

Cable/connection

Sensor

Exit

25.08.2012 10:34

Appropriate instructions appear for each source of faults.

Perform the measure in accordance with the recommendation.

Continue with >Explanation<.

1.10 Service Wizard 

Please check the sensor for plausible values.

Explanation

25.08.2012 10:34

1.10 Service Wizard 

Disconnect it
and measure
its resistor.

Next

25.08.2012 10:34

A part of the information and instructions may be provided in close detail, so that ...

1.10 Service Wizard 

With PT 1000 sensors
0°C to 100°C
correspond to
a resistor of
1000 to 1385 Ohm.
Is your measured
value within

25.08.2012 10:34

...the texts may well take several screens.

1.10 Service Wizard 

correspond to
a resistor of
1000 to 1385 Ohm.
Is your measured
value within

Yes
No

25.08.2012 10:34

After description of the troubleshooting measure, the result determined by you is interrogated...

... and the appropriate logical conclusion is made, the repair work displayed.

1.10 Service Wizard 

Sensor is faulty and must be replaced.

[Exit](#)

25.08.2012 10:34

After elimination of the malfunction, the plant screen without the >Attention< symbol appears again on the display, automatic mode is continued.

System 11

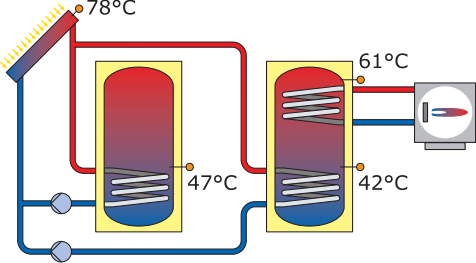

25.08.2012 10:38



Danger!

Mortal danger due to electrocution! Before opening the terminal cover, disconnect the power supply reliably!

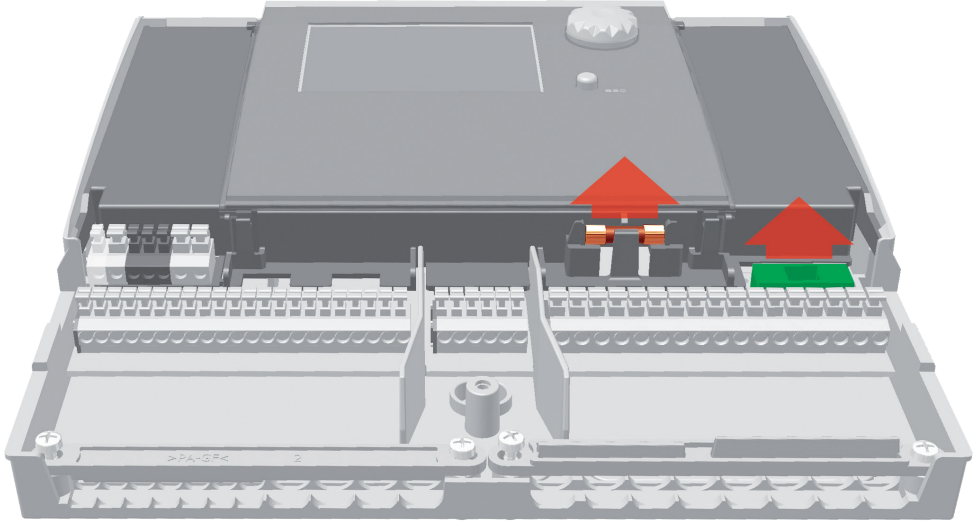

To remove the device fuse, open the terminal cover. Above the right-hand group of terminals, the fuse base and a spare fuse are located. Pull the upper part of the support and the spare part out. The fuse link is clamped in the formed piece and is removed together with the plastic holder.

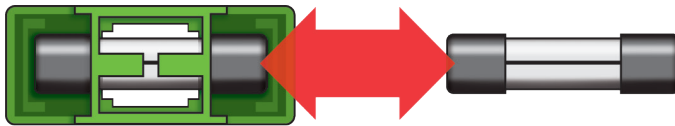

Now, push the micro-fuse laterally out of its holder. The fuse link is installed by reversing the above order. Make sure to procure yourself immediately a new spare fuse!



Danger!

Risk of fire due to overload or short-circuit!
Only use fuse links type 5 x 20 mm, T4A!



Important!

In professional mode, settings are made which require detailed knowledge of the heating and solar plant. Moreover, solid specialist knowledge regarding control engineering, hydraulics and solar thermal water heating is required!

If a single parameter is changed, this may affect the safety, function and efficiency of the entire plant!

Leave the settings in professional mode to a specialist workshop, the fitter or heating installer!

Modifications by non-experts tend to result in damage to the plant, rather than to an improvement of its efficiency!

To enter the professional mode, select >1.7 Login< from the main menu, activate and ...

... enter the access code.

The access code to professional mode is >365<.

The fact that the fitter must be available for his/her customers on 365 days per year may serve as a mnemonic trick.

1.7 Login

Access code 0

25.08.2012 10:29

Edit

Access code 365

Restore last value

Factory settings

25.08.2012 10:31

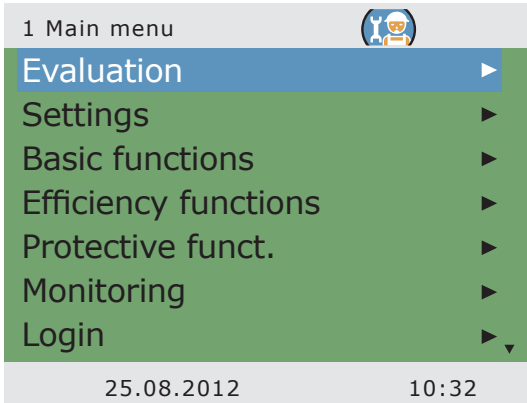

After having returned to >1 Main menu<, the screen shows a list of subitems as in operation mode.

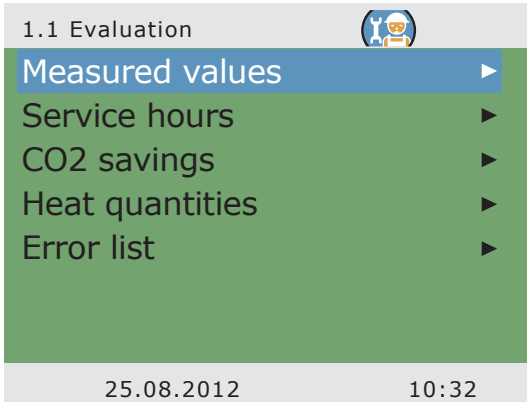

The menu >1.1 Evaluation< is identical to the operating mode.

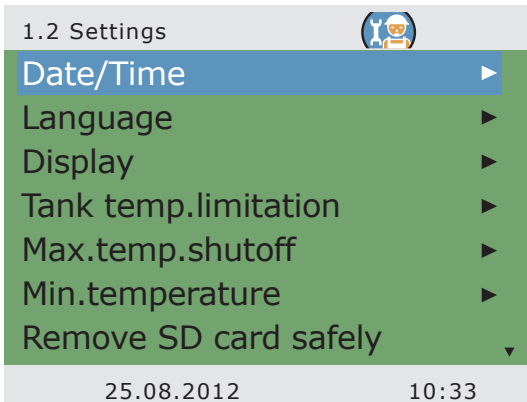

The following items appear under >1.2. Settings< next to the operation mode menus:

- >Temp. limitation<
- >Max.temp.shutoff<
- >Min. temperature<
- >Priority charging<

Call up menu item >Temp. limitation<.

If the temperature in tank 1 exceeds the value T limit 1, or if the temperature in tank 2 exceeds the value T limit 2, the solar circuit pump is switched off unconditionally.

The pump is not switched on again until the actual temperature falls below the value T limit by the hysteresis >Hyst<.

Example: T limit =60°C minus Hyst=5K => Reclosing temperature 55°C.

Continue via the menu item >Max.temp.shutoff<.

Maximum temperature of the tanks 1 and 2, to avoid excessively hot water in the tank; the tank in question is only charged to its >T max<.

In case of collector overheating, the tank can be charged up to >T-limit<.

Continue via the menu item >Min. temperature<.

To increase efficiency on charging the tanks, the minimum temperature to be present at the collector in question is entered via >T min. Coll<.

The relevant hysteresis value represents the difference between the switch-ON and switch-OFF temperature.

Continue via the menu item >Priority charge<.

1.2.3 Temp.limitation 

Hysteresis 5.0K

T limit 1 60.0°C

T limit 2 60.0°C

If T-limit>60°, anti-scalding protection must be installed.

25.08.2012 10:34

1.2.5 Max.temp.shutoff 

T max.tank 1 59.0°C

T max.tank 2 59.0°C

25.08.2012 10:34

1.2.6 Min. temperature 

Activation

T min.Collector 1 20.0°C

Hyst. Collector 1 2.0K

25.08.2012 10:34

1.2.8 Priority charging 

Priority	Tank 1
Pause time	2min
Charge time	20min
dT Collector	2.0K

25.08.2012 10:34

In case of dual-tank systems, the tank to be charged first is defined: tank 1, tank 2 or parallel charging.

>t pause< is used to set the pause time between twot switch-ON tests.

>t charge< serves to define the charging time for the secondary tank.

Once >dT Coll< is reached, the pause time is restarted.

Continue with >Basic functions<.

1.3 Basic functions 

- Thermostat ▶
- Output parameter ▶
- Tube collector ▶
- Holiday function ▶
- Collector cooling ▶
- Commissioning ▶
- Delta T control ▶

25.08.2012 10:35

The following items appear under >1.3. Basic functions< next to the operation mode menu:

- >Thermostat<
- >Output parameter<
- >Collector cooling<
- >Post Heating Requ. ...

1.3 Basic functions 

- Holiday function ▶ ▲
- Collector cooling ▶
- Commissioning ▶
- Delta T control ▶
- Fixed T control ▶
- Post Heating Request ▶
- Increase return T ▶

25.08.2012 10:35

... and enhanced menus regarding the

- >Holiday function<
- >Delta T control<
- >Fixed T control<
- >Increase return T<

Call up the menu item >Thermostat<.

If outputs on the controller are not assigned, these channels can be used as thermostats.

Here, the appropriate channel is selected.

1.3.1 Thermostat 

Thermostat RO3 ▶

Thermostat RO4 ▶

25.08.2012 10:35

Perform activation.

Define the start signal.

Depending on the selection of >Start<, the following parameters are shown.

The output has already been defined by the selection - the related sensor remains to be defined.

Define switch-ON/OFF temperature.

Continue to scroll.

1.3.1 Thermostat RO3 

Activation

Start Timer, thermostat

Sensor	---
Output	RO3
T ON	0.0°C
T OFF	0.0°C ▼

25.08.2012 10:35

For the heating function, T ON must be < T OFF.

For the cooling function, T ON must be > T OFF.

Up to four time slots can be assigned to each thermostat function. Define times for activation and deactivation.

Continue via the menu item >Output parameter<.

1.3.1 Thermostat RO3 

t ON 1	00:00 ▲
t OFF 1	00:00
t ON 2	00:00
t OFF 2	00:00
t ON 3	00:00
t OFF 3	00:00
t ON 4	00:00 ▼

25.08.2012 10:35

1.3.7 Output parameter



Solar pump 1	▶
Solar pump 2	▶
Boiler	▶
Thermostat RO3	▶
Time for tear-off	10s
Speed for tear-off	100%
Speed delta	10%

25.08.2012

10:35

Here, the general settings for the assigned outputs are defined.

>t tear-off< and >n tear-off< define how long and at which speed the pumps are to run on starting.

Select an output...

Note!

The >Speed delta< parameter defines the speed change for step control. Speed is adjusted by each set value by changing the temperature.

Step control is either selected in the >1.3.5 dT control< menu or in the >1.3.6 Fixed T control< menu.

Parameters for the following sample diagram:

n-min = 30% / n-max = 100% / algorithm = dT (menu 1.3.7) /
 dT 1 = 2.0K / dT-on 1 = 5.0K / dT-target 1 = 10.0K /
 control 1 = stepped (menu 1.3.5) / speed delta = 10% (menu 1.3.7).

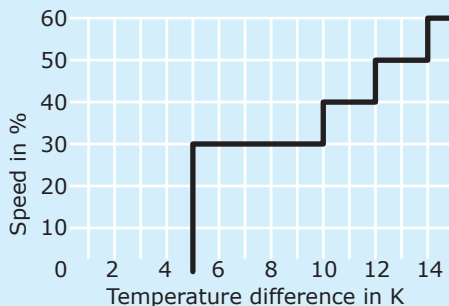

...to define the required control algorithm as >dT< or >Fixed T<.

In case of plants with long piping or slow response, overtravel times for the solar circuit, pump and valve can be determined.

Continue to menu item >Tube collector<.

1.3.7 Output parameter 

Algorithm, output control dT

Overtravel time	0s
min. pump speed	50%
max. pump speed	100%

25.08.2012 10:35

To receive correct measured values from the tube collector system, the pump must be switched ON briefly.

By activation of the function, the solar circuit pump can be started time- and/or temperature-controlled.

The time sequence, the pump ON time and ...

1.3.2 Tube collector 

Activation

Start	time-dependent
t-ON restart	10min
T-ON restart	20.0°C
t solar 1	20s
n solar 1	100%
t solar 2	0s ▼

25.08.2012 10:35

... the pump delivery rate as a percentage value can be entered.

The two time programs are performed one after the other.

Continue via the menu item >Holiday function<.

1.3.2 Tube collector 

T-ON restart	20.0°C ▲
t solar 1	20s
n solar 1	100%
t solar 2	0s
n solar 2	30%
Start time	06:00
End time	20:00

25.08.2012 10:35

1.3.3 Holiday function 	
Start of holiday	19.07.2013
End of holiday	02.08.2013
<hr/>	
Tank cooling	<input checked="" type="checkbox"/>
Start	00:00
End	07:00 ▼
25.08.2012	10:35

To avoid overheating of the plant, the controller will suppress yield optimization while the holiday function is activated.

The time frame of the holiday function is mostly defined in operation mode.

If tank cooling is activated, an appropriate time frame must be defined - this makes sense during the cooler hours of the night - by allowing the controller to dissipate as much energy as possible via the collectors.

Continue to scroll.

1.3.3 Holiday function 	
Re-cooling	T-min tank ▲
n pump	100%
Hyst.	5.0K
<hr/>	
Soft charge	<input checked="" type="checkbox"/>
dT	5.0K
25.08.2012	10:35

Under >Recooling<, determine whether cooling is to be effected down to >T min tank< or >T max tank<.

Under >n pump< set the pump speed in percent.

Enter the hysteresis value by >Hyst<.

If necessary, activate >Soft charging<

>dT< is used to define the switch-ON temperature for the holiday function as a difference from the preset maximum temperature of the tank.

Continue to scroll.

Via ›T-min tank 1‹ and ›T-min tank 2‹, specify the minimum temperature required for the tank in question.

Select whether the ›Priority tank‹ or the ›Secondary tank‹ are to be cooled.

Continue via the menu item ›Collector cooling‹.

Here, collector cooling is activated: once the collector temperature ›T max. Coll. 1‹, or ›T max. Coll. 2‹ is reached, the appropriate solar circuit pump continues to operate until the tank limit temperature is reached.

To protect the pump, the collector emergency switch-off in solar circuits with high-efficiency pumps is reduced to 100°C. Collector cooling is not possible at higher temperatures!

Return to ›1.3. Basic functions‹.

Continue with ›Commissioning‹.

Here, new commissioning can be started - e. g. if a new hydraulic system is to be selected.

=> ›Commissioning mode‹ as of page 61.

Continue with ›Delta T control‹.

1.3.3 Holiday function 

Hyst	5.0K [▲]
Soft charge	<input checked="" type="checkbox"/>
dT	5.0K
T min.tank1	45.0°C
T min.tank2	45.0°C

Tank

Priority tank

25.08.2012 10:35

1.3.4 Cooling funct. 

Activation	<input checked="" type="checkbox"/>
T max.Collector 1	121.0°C

25.08.2012 10:36

0 Welcome 

You really want to start commission.?

No Yes

25.08.2012 10:36

1.3.5 dT control 

Activation dT 1

dT 1	2.0K
dT-ON 1	8.0k
dT-OFF 1	4.0k
dT targ.1	10.0K
Contl 1	step-wise

25.08.2012 10:37

If control algorithms have been defined as >dT< under >1.3.7 Output parameter<, the appropriate outputs can be configured here.

Via >dT ON<, the switch-ON temperature, via >dT OFF<, the switch-OFF temperature and via >dT targ.<, the target differential temperature are set. (Differential temperature between collector and tank, bottom).

Continue with >Fixed T control<.

Note!

The >dT targ.1< parameter is displayed in the >1.3.5 dT control< menu for systems with 2 collector fields.

With >dT targ.1< the maximum temperature difference between both collector sensors is specified.

Once this value is exceeded, the pump of the „colder“ collector field is deactivated in order to increase efficiency.

1.3.6 Fixed temp.cont... 

Control 2

Variante 2

	step-wise
T-fixed 2	70.0°C

25.08.2012 10:37

If control algorithms have been defined as >Fixed T< under >1.3.7 Output parameter<, the appropriate outputs can be configured here.

In case of the fixed temperature control, the collector is controlled to the preset temperature via a variable pump delivery rate.

Continue with >Post Heating Request<.

Here, reheating can be activated.

The boiler is defined as ›Solid-fuel boiler‹ or ›Gas/oil‹.

In case of solid-fuel boilers reheating is made via the charge pump of the drinking water tank and is only activated if the temperature of the tank is within the values ›Min. temp.‹ und ›Max. temp.‹.

Use ›Boiler sensor‹ to assign the temperature sensor which supplies the temperature value of the boiler.

Up to six time blocks can be activated for reheating.

›Ref. temp.‹ is used to define the set temperature at the top tank sensor.

If the temperature falls below ›Ref. temp.‹ by ›Hysteresis‹, the control activates the reheating cycle via the heating boiler until ›Ref. temp.‹ is reached.

Each period can be defined with ›Weekends‹, Monday - Sunday‹ or ›Monday - Friday‹.

Continue with ›Efficiency functions‹.

1.3.10 Post Heating R... 

Activation

Boiler type Solid fuel boiler

Hysteresis 10.0K

Minimum temperature 40.0°C

Maximum temperature 55.0°C

Sensor boiler TS6 ▾

25.08.2012 10:37

1.3.10 Post Heating R... 

Sensor boiler TS6 ▲

Time block 1 ▶

Time block 2 ▶

Time block 3 ▶

Time block 4 ▶

Time block 5 ▶

Time block 6 ▶

25.08.2012 10:37

1.3.10 Post Heating R... 

Activation

Reference temperature 45.0°C

Starting time 00:00

End time 23:59

Time period Daily

25.08.2012 10:37

1.4 Efficiency functions 

Low-Flow ▶

Quick-charging ▶

Disable recharge ▶

Efficient tank-charge ▶

25.08.2012 10:38

The following items appear under >1.4. Efficiency funct.< next to the operation mode menus:

- >Low-Flow<
- >Quick-charging<
- >Efficient tank-charge<

Call up menu item >Low-Flow<.

1.4.1 Low-Flow 

Activation

T ON 60.0°C

25.08.2012 10:38

Here, the switch-ON temperature can be defined for low-flow plants.

Continue with >Quick-charging<.

1.4.2 Quick-charging 

Activation

Sensors ---

T ON 48.0°C

T OFF 52.0°C

Collector target temp. 70.0°C

25.08.2012 10:38

Tank quick charging changes over from dT control to fixed temperature control.

>T ON< and >T OFF< define the change-over range and >T targ.< the fixed temperature on the collector.

An upper tank sensor is required for quick-charging.

Continue with >Disable recharge<.

If the plant has been designed accordingly and a system involving disable recharge selected, the appropriate parameters are set here.

Here, the time control and/or the temperature control are activated - possible for all systems with heating boiler control.

Time and temperature control can be used in combination.

Select the time slot via >Start< and >End<.

Select the minimum temperature via >T min tank<.

Here, the efficiency-optimized disable recharge is enabled and activated - possible for all systems with heating boiler control.

Set >factor 1<.

Factor 1 assesses solar yield, factor 2 assesses comfort.

By reducing factor 1, the expected solar input gets a higher weighting.

Set >factor 2<.

Reducing factor 2 will decrease comfort.

Determine under >T floating< whether the temperature is to be measured on the upper or lower tank sensor.

Enter the minimum tank temperature via >T min tank<.

Continue with >Efficient tank-charge<.

1.4.3 Disable recharge

Activate time program	☑
Start	00:00
End	00:00
<hr/>	
Activat, T-min	☑
T min. tank	45.0°C
<hr/>	
Activat.Tmin float	☑

25.08.2012
10:39

1.4.3 Disable recharge

Factor 1	4.0 ▲
Factor 2	2.0
T target	45.0°C
T floating	upper tank sensor
T min. tank	45.0°C

25.08.2012
10:39

1.4.4 Efficient tank ch... 

Activation

t delay after t. change 4.5min

Performance delta 100W

25.08.2012 10:39

>Efficient tank charge< is activated and configured here.

The solar circuit pump is controlled according to the entered heat quantity. In order to use this functionality, a heat quantity counter must be configured in the solar circuit (=> >1.1.4 Heat quantities< menu).

The >t delay after t. change< parameter defines the time between two speed changes. Once the waiting time has expired, the speed of the solar pump is increased or decreased by 10%.

With the >Performance delta< parameter, the additional yield which is necessary during the waiting time for the pump speed to change accordingly is set .

Return to >Main menu<.

Continue with >Protective funct.<.

1.5 Protective funct. 

Anti-blocking ▶

Collector defrosting ▶

Antifreeze protection ▶

Anti-legionellae ▶

Tank cooling ▶

Soft charge ▶

25.08.2012 10:40

The following items appear under >1.5. Protective funct.< next to the operation mode menus:

- >Anti-Blocking<
- >Anti-legionellae<
- >Antifreeze protection<

Call up menu item >Anti-Blocking<.

The pumps can be moved daily to prevent them from getting blocked.

This function is not activated as long as the pumps are activated in normal operation.

Determine the time of the day and the operating period.

Continue with >Collector defrost.<.

1.5.1 Anti-block protect. 

Start	11:00
Duration	5s

25.08.2012 10:40

>Defrosting< can be used to heat frozen collectors.

At the same time, the tank is cooled!

Set the pump runtime.

Continue with >Antifreeze protect.<.

1.5.2 Defrosting 

Activation	<input checked="" type="checkbox"/>
Max. pump t defrosting	5min

25.08.2012 10:41

1.5.3 Antifreeze prote...		
Activation		<input checked="" type="checkbox"/>
T ref	5.0°C	
T ON	5.0°C	
Glycol type	Water	
Tank	Priority tank	
25.08.2012		10:42

Activation and setting of the anti-freeze protective function for the collector.

Via >T ON<, enter the anti-freeze protection temperature for water-filled plants.

When anti-freeze products are used, the type and the proportion can be entered; the anti-freeze protection temperature is calculated automatically.

In the case of plants with two tanks, the source of the anti-freeze protection heat must be selected by specifying >Priority tank< or >Secondary tank<.

Continue with >Anti-legionellae<.

1.5.4 Anti-legionellae		
Repetition	1 day	
T legionellae	60.0°C	
t ON	01:00	
t monitor	60min	
Activation		<input checked="" type="checkbox"/>
25.08.2012		10:43

These parameters must be set by the fitter based on the applicable national regulations. >Function< is used to define the period in days (1 - 7) during which legionella reduction must have occurred at least once.

>t-ON< is used to define the time of a possibly required reheating cycle.

>T legionellae< defines the disinfection temperature. >t monitor<< is used to define the minimum disinfection time.

Continue with >Tank cooling<.

Here, the parameters for tank cooling are defined.

>t-ON< and >t-OFF< are used to define the appropriate time slot in which the tank is to be cooled via the collector, and >Hyst.tank 1< and >Hyst.tank 2< are used to define the switch-ON hysteresis.

If the adjusting balance is activated, the heat dissipated via the collector is deducted from the energy balance calculation.

Continue with >Soft charge<.

1.5.5 Cooling funct. 	
Activation	<input checked="" type="checkbox"/>
Hyst.tank 1	2.0K
Hyst.tank 2	2.0K
t ON	00:00
t OFF	07:00
Adjusting balance	<input checked="" type="checkbox"/>

25.08.2012 10:43

Note!

To protect the pump, the collector emergency switch-off in solar circuits with high-efficiency pumps is reduced to 100°C. Soft charge is not possible at higher temperatures!

Soft charging sets the plant to protection mode to prevent excessively high tank temperatures.

The start temperatures for two tank circuits and the appropriate calendar period are determined here.

Return to >Main menu<.

Continue with >Monitoring<.

1.5.6 Soft charge 	
Activation	<input checked="" type="checkbox"/>
T min. tank 1	45.0°C
T min. tank 2	45.0°C
Start	30.05.
End	31.07.

25.08.2012 10:43

1.6 Monitoring 

Error list ▶

Differential temp ▶

Volume flow ▶

Collector Emergency OFF ▶

Sensor balancing ▶

25.08.2012 10:44

The following items appear under >1.6. Monitoring< next to the operation mode menus:

- >DiffTemp<
- >Volume flow<
- >Coll.Emerg.OFF<
- >Sensor balancing<

Call up the menu item >DiffTemp<.

1.6.2 dT-monitoring 

dT coll/stor 30.0K

t max coll/tank 10min

Monitoring of ---

25.08.2012 10:44

>dT monitoring< is used to define the criteria which lead to fault detection.

>dT coll/stor< is used to define a differential temperature between collector and tank, and >t max.coll/tank< for the relevant period of time.

If >dT coll/stor< is exceeded within >t max.coll/tank<, the controller detects a fault.

With >Monitoring of<, the monitoring of the feed and return temperature of the heat counter can be selected.

Continue with >Volumenstrom<.

>Phi monitoring< accesses any flow menu for which volume flow sensors have been configured.

Select appropriate submenu.

1.6.3 Phi monitoring 

flow rate RO1 

25.08.2012 10:44

Here, the parameters for volume flow monitoring are defined.

Continue with >Coll. Emerg.OFF<.

1.6.3 Phi monitoring 

phi min.error 0.10l/min

phi circulation 1.00l/min

t undercut 5min

25.08.2012 10:44

>T limit Coll. 1< or >T limit Coll. 2< are used to switch OFF the appropriate solar circuit pumps to prevent destruction.

To protect the pump, the collector emergency switch-off in solar circuits with high-efficiency pumps is reduced to 100°C.

Under >Hysteresis, pump release<, the value is entered by which the limit temperature must be undercut to cancel the forced shut-off.

Continue with >Sensor balancing<.

1.6.4 Emerg.OFF 

T limit Collector 1 130.0°C

Hysteresis, pump release 5.0K

25.08.2012 10:45

1.6.5 Sensor balancing 

TS1 Offset value	0.0°C
TS2 Offset value	0.0°C
TS3 Offset value	0.0°C
TS4 Offset value	0.0°C
TS5 Offset value	0.0°C
TS6 Offset value	0.0°C
TS7 Offset value	0.0°C

25.08.2012 10:46

Long piping and other factors may distort measured variables.

Here, an offset value can be entered for each sensor.

Return to >Main menu<.

Continue with >Login<.

1.7 Login 

Access code 365

Manual mode ▶

Firmwareupdate USB

25.08.2012 10:47

Continue with >Manual mode<.

1.7.1 Manual mode 

Solar pump 1	<input checked="" type="checkbox"/>
Solar pump 1	100%
Solar pump 1	---
Solar pump 2	<input checked="" type="checkbox"/>
Solar pump 2	100%
Solar pump 2	

25.08.2012 10:48

In manual mode, the individual outputs can be activated for testing purposes, e. g. to check that a pump is working properly.

Manual mode can only be exited by pressing ESC.

Return to >Login<.

Continue with >Firmwareupdate USB<.

Note!

After the selection of the >USB firmware update<, the display flashes every second.

Use a USB cable to connect to a PC already installed with update software.

If controller and PC have already been connected, they must be briefly disconnected again.

The update software uploads the DFU file.

The display continues to flash and the progress is displayed on the PC.

If the update has not begun within one minute after the selection of >USB firmware update<, the controller will restart.

If professional mode is not quit actively, the controller automatically shows the system overview after the preset display disconnecting time, and the value of the access code is reset to 1.

System 11

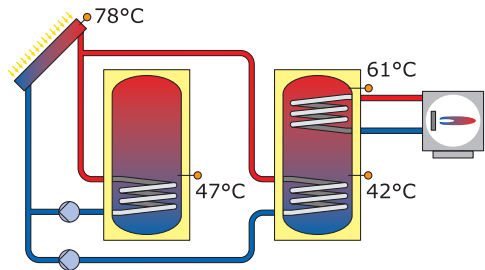

25.08.2012

10:49



Danger!

Mortal danger due to electrocution!
Before opening the terminal cover,
disconnect all poles of the power supply reliably!



For disassembly of the differential temperature controller **smart Sol plus**, reverse assembly procedure:

- Disconnect the power supply.
- Open the terminal cover.
- Disconnect all cables.
- Release the wall screw fastening.
- Remove the controller from its mounting location.



Danger!

Mortal danger due to electrocution!
When removing the controller, secure all stripped
cable ends so that they cannot be touched by persons!

Remove cables completely on definite removal.



Important!

The person who or the institute which is responsible for disposal of the device must not discard the controller with the residual waste, but must ensure correct recycling in accordance with the local provisions!

In case of doubt, ask the local disposal company or the authorized dealer from which you have purchased the device.



Warranty and liability

The differential temperature controller **smart Sol** was developed, manufactured and tested according to stringent quality and safety specifications and corresponds to the state of the art.

The device is subject to the warranty period prescribed by law of 2 years after the date of sale.

The seller shall eliminate all defects in material and workmanship which occur on the product during the warranty period and which impair the product's functionality.

Natural wear and tear does not constitute a defect.

Warranty and liability does not include all damage which is due to one or several of the following reasons:

- Non-compliance with these Assembly and Operating Instructions.
- Inappropriate transport.
- Faulty assembly, commissioning, maintenance or operation.
- Modifications of the structure or tampering with the software of the device.
- Installation of supplementary components which are not approved by the manufacturer.
- Continued use of the controller despite an obvious defect.
- Use of non-approved spare parts and accessories.
- Applications exceeding the intended scope of utilization.
- Inappropriate utilization of the device / improper handling, e. g. ESD.
- Use of the device outside of the admissible technical boundaries.
- Voltage surges, e. g. due to lightning strokes.
- Force majeure.

Further claims based on this warranty obligation, especially compensation for damage exceeding the asset value of the differential temperature controller, are excluded.

Construction, design and project engineering of heating installations are performed by specialist fitters based on the applicable standards and directives.

The functioning and safety of a plant are the exclusive responsibility of the companies commissioned with planning and execution.

Contents and illustrations of this manual have been elaborated to the best of our knowledge and with utmost diligence - we reserve the right of error and technical modifications.

Liability of the manufacturer for inappropriate, incomplete or incorrect information and all damage resulting therefrom is excluded on principle.

Error pattern/error description:

Error message:

Software version:

Service Wizard executed: Yes No _____

Screens: TS1: TS2: _____

TS3: TS4: _____

TS5: TS6: _____

TS7: TS8: _____

Wiring: RO1: Pump HE Valve _____

RO2: Pump HE Valve _____

RO3: Pump HE Valve _____

RO4: Pump HE Valve _____

REL: Yes No _____

Service hours: RO1: RO2: _____

RO3: RO4: _____

REL: _____

Equipment/Accessories/Options:

Important!

For repair or replacement of the controller, make sure that completed copies of the commissioning report and of the error report are included!



Commissioning report

Name of operator and place of installation:

Date of commissioning:

Installed hydraulic system:

Collector surface, in total [m²]:

Tank sizes [l]:

Anti-freeze agent Type/concentration:

Particularities:

The solar thermal plant with the differential temperature controller **smart Sol plus** has been installed and commissioned in an expert fashion.

The owner / operator of the plant was informed in detail and instructed as regards the design, operation, handling, especially in connection with the differential temperature controller **smart Sol plus**.

Commissioning by the company (name/address/telephone number):

Name of employee:

We, **emz-Hanauer GmbH & Co.KGaA**
Siemensstraße 1
D - 92507 Nabburg,

herewith declare in sole responsibility that the following products:

Device type: **Differential temperature controller
for the control of solar thermal plants**

emz product designation	emz order no.	from manufacturer date
smart Sol plus Premium	51.0042	11/2012
smart Sol plus Excellence	51.0041	11/2012

complies with EMC Directive 2004/108/EC and with the Low Voltage Directive 2006/95/EC and with the standard requirements resulting hereof.

Technical regulations:

Low voltage directive :

IEC 60730-1:1999 (3rd Edition) + A1:2003 + A2:2007

EN 60730-1:2000/AC:2007

EMC directive :

EN 60730-1:2000

+ A1:2004 + A12:2003 + A13:2004 + A14:2005 + A16:2007 – A2:2008,
Cor of DIN EN: 2009-06; Cenelec cor.:2010 (EMC section, type 2 control)

EN 55022:2010 (class B)

EN 61000-3-2:2006 + A1:2009+ A2:2009

EN 61000-3-3:2008

Notes:

The original copy of the test reports is available at emz.

D - 92507 Nabburg, 29.11.2012,

Signed by

Thomas Hanauer
Managing Director

pp Josef Irlbacher
Head of the Electronic Development Team

Index

A			
Active system	12	Legend to symbols	20
Antifreeze	99	Login	74/84
Anti-blocking	98	Low-Flow plant	95
Anti-legionella function	51/99	M	
Automatic mode	61	Malfunction	76 ff.
		Manual mode	103
B		O	
Break-out segments	10/15	Operation of the controller	11
Brightness	68	Output parameter	89 f.
C		P	
Cable cross sections	9	Phi monitoring	102
Cable diameter	15	Priority charge	87
Cleaning	6	Professional mode	84 ff.
Collector cooling	92	Protective functions	97
Commissioning mode	55	PWM control signal	17
Connection	15 ff.	Q	
Connection diagram, switching valve	16	Quick-charging	95
D		R	
Data interfaces	19	Reduction of legionella	51
Date/Time	67	Reheat function	51/94
Defrosting	98	Rotary encoder	11
Description	6	S	
Differential temperature	17	Scope of Supplies	8
Disable recharge	51/96	Sensor balancing	103
Disposal	105	Sensor line	6
E		Service wizard	76 ff.
Efficient tank charge	97	Soft charge	73/100
Emergency OFF	102	Software version	74
Error list	66/74	Solar yield	17
Evaluation	63 ff./85	Speed delta	89
F		Strain relief device	10/15
Firmware update	104	Switching valve	16
Functions for boiler control	51 ff.	T	
G		Tank cooling	73
Guided diagnostic process	76 ff.	Temperature sensor	6
H		Thermostat functions	54
High-efficiency pump	17	Tube collector	69/90
Holiday function	60/70/91	V	
Hydraulic systems	21 ff.	Volumetric flow sensor	17
		Vortex sensor	17
I		W	
Impeller	17	Wall-mounting	13
Intended Use	8		

emz-Hanauer GmbH & Co.KGaA
Siemensstraße 1 • D - 92507 Nabburg
Telephone + 49 - (0) 94 33 - 89 8 - 0
Telefax + 49 - (0) 94 33 - 89 8 - 188
info@emz-hanauer.com

www.emz-hanauer.com

